

Issue # 9

US \$4.95

BattleTechnology

The Magazine of Combat in the 31st Century



War Over



THEY ARE COMING.

NOTHING WE HAVE CAN STOP THEM.

MICHAEL A. STACKPOLE

LETHAL HERITAGE

BLOOD OF KERENSKY • VOLUME ONE

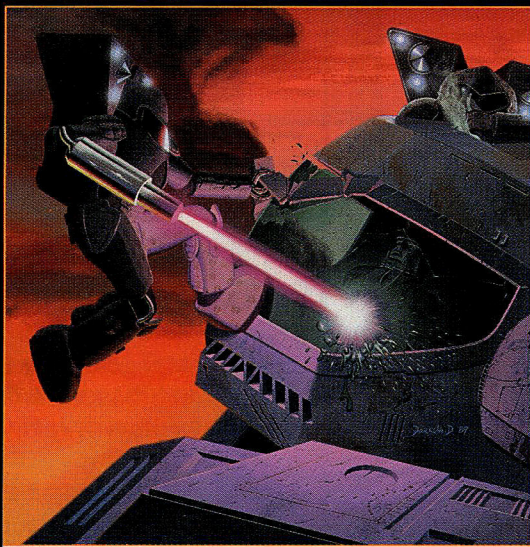

A BATTLETECH NOVEL

From beyond the Periphery

comes a threat. A threat

whose power, speed, and

ferocity are unparalleled. A

juggernaut whose sole

reason for being is battle.

THE CLANS.

Humanity's only hope is for Davion and Kurita to stand side by side.

Lethal Heritage is the first of a new trilogy by Michael A. Stackpole, author of the *Warrior Series*. Look for *Lethal Heritage* in July where you buy games.

BATTLETECH is a Registered Trademark of FASA Corporation. Lethal Heritage is a trademark of FASA Corporation. Copyright © 1989 FASA Corporation. All rights reserved. FASA Corporation, P.O. Box 6930, Chicago, IL 60680.

FASA products are exclusively distributed by JM Games • Chart House • Station Road • East Preston • Littlehampton • West Sussex • BN16 3AG • England, and by JEDKO Games • 134 Cochranes Road • Moorabbin, Victoria • Australia 3189.

BattleTechnology

The Magazine of Combat in the 31st Century

Issue # 9
March 3030

Publisher: Jeffrey Tibbetts
Assistant to the Publisher: Hilary Ayer

Editor: Bob Carter
Editorial Coordinator: Hilary Ayer
Founding Editor: William H Keith Jr
Founding Art Director: Nina Barton
Limited Consultant: Robert Tibbetts

Editorial Offices:
BattleTechnology
3833 Lake Shore Avenue
Oakland, CA 94610

BattleTech, *CityTech*, *AeroTech*, *Mech*, *MechWarrior*, and *BattleForce* are registered trademarks of FASA Corporation, Chicago, Illinois, and are used with permission.

PACIFIC RIM PUBLISHING COMPANY
3833 Lake Shore Avenue
Oakland, CA 94610

Kenneth Gaydish Chairman
Jeffrey Tibbetts President

BattleTechnology The Magazine of Combat in the 31st Century [ISSN 0895-030X] is published bimonthly by Pacific Rim Publishing Company, 3833 Lake Shore Avenue., Oakland, California 94610. Subscription rates are \$24.00 for six issues in the USA, APOs, and FPOs; \$30.00 for six issues in Canada; \$48.00 for six issues elsewhere via air mail. All payments must be made in US funds drawn on accounts in the USA or postal money orders. POSTMASTER: Send address changes to BattleTechnology, P.O. Box 23651, Oakland, CA 94623. BattleTechnology is a publication of Pacific Rim Publishing Company. Printed in the USA. Copyright 1988 Pacific Rim Publishing Company. All rights reserved.

Cover: Michael Haggerty and Nelson Snook
Photography: Nelson Snook and Michael Haggerty
Art in this issue:

Lynx
by Eric Gaydish
Marik Gathering, Snowfire, Mohammed Kimbrough
by Charles Pitman
Princess Melissa and Kell Hound Statue
by Mac Art Productions
BTE Blueprint
by Gary A Kalin
All other Art by William H Keith Jr

Correction of BattleTechnology # 8

The FLE-14 Mech design by Dale Kemper

Writing in this issue:

BTE Beatie Hovertank
by Dale Kemper
Princess Melissa Interview
by Michael A Stackpole
Skyfall, VTOL Gunships
by Thomas Gressman
Assault on Jump Station Kusari Story and Scenario
and *Gehenna Revisited*
by John A Theissen
Lynx by Robert A Gross Jr
King of the Hill, Ghost Lady and the Wolf, Assassination, Tooth & Claw, 2 BattleTechnology News
by Stefan Paul Melin-Dempsey
Touch Not the Wolf
by Stefan Paul Melin-Dempsey and Hilary Ayer
All other writing this issue by Hilary Ayer

About the Cover:

Vid fans will recognize the restaging of the battle of Tartarus Caldera NOT approved by any of the participating units from 3029's greatest hit in Marik space *Blood Revenge of the Wenches*™

Contents

Skyfall	8
Maj Kensie Shaneyfelt	
Assault on Jump Station Kusari	20
Sandusky Sorrell	
House Marik, Survival in a Hard School	32
BattleTechnology Sources	

DEPARTMENTS

BattleTechnology News Service	4
News From the Front	
Peace Breaks Out	6
BattleTechnology Interviews	
Princess Melissa Steiner-Davion	14
Mech(Warrior)Tac	
The Theory and Practice of Assassination	34
Unit Update: Touch Not the Wolf	54
BattleMechanics—	
Technical Readout	
BTE Beatie Hovertank	28
BattleTechnology Blueprint # 2	
Beatie Hovertank	30
Technical Readout	
Lynx BattleMech	52
Where were you?	60

BATTLETECH SIMULATOR

Scenarios:

King of the Hill	40
The Ghost Lady and the Wolf	57
Tooth and Claw	58

More Than Warriors —

Gehenna Revisited	60
Sandusky Sorrell	

Distribution:

American & Canada: Your favorite Game or Comic Distributor

Australia:

Jedko Games, 134 Cochranes Rd, Morabbin, Victoria 3189

UK & Europe:

TM Games, Chart House, Station Rd, East Preston, Littlehampton West Sussex BN 16 3AG, England

OPENING SHOTS



Peace



Peace. The Fourth Succession War is over. Can you believe it yet?

I can't even be glad for it yet because I can't realize it. I don't remember what peace feels like, do you? Nights where you sleep deeply and dream of something besides the aerospace raid warning. No more worrying that the messenger is coming from defense to tell you someone you love isn't...there any more. No more worrying about your Aunt Sylvia who went to the wrong place on vacation. YOU CAN ACTUALLY SIT THERE AND REPAIR YOUR 'MECH! YOU CAN EVEN PUT PAINT ON IT WITH SOME HOPE IT WILL STAY THERE! Rationing still continues, but small frivolous items appear next to the preweighed packets. There were new vids from Oriente beside the too-small boxes marked "Sugar for ____ individuals for one week".

I remember the crowds in the square watching the public vidscreen last week. Suddenly it didn't seem like a time to be alone. We listened to Archon Katrina Steiner say "I will fight no more forever." Here on Atreus they don't believe a Lyran would say that. Everybody taped it. Captain-General Janos Marik gave a speech to his people which I don't think has appeared outside the Free Worlds League. "Let us regard ourselves as challenging them in peace as we did in war. Let them attempt to excel in peaceful commerce...and let us show them how well a free people which has not begun a recent costly war can corner the market...on peace. If good intentions are to become a saleable commodity, in this as in all things we can outproduce the Lyrans. The terms of the treaty are honorable; the entire text will be made public. I have therefore signed it in your name. The bottom line is this: no more of our citizens will die this year."

It's true that the Free Worlds League has suffered the least in this war; anyone who's seen the gray ruins of the Capellan border planets knows how much more serious it could have been here. Other reporters for BattleTechnology will interview leaders across the Known Sphere. But Janos Marik said it for me, "No more of our people will die this year." The Fourth Succession War is over. There will be local conflicts, but the system-wide disruption which has wrenched and altered each of our lives is done.

In this issue, Bob Carter, a Wolf-watcher from way back, reviews the bravery of Wolf's Dragoons. Sandusky Sorrell gives us recent news of Galt's Grenadiers. We are privileged to print an interview of Princess Melissa Steiner-Davion in wartime. A certain private viddiary was made available to us (see page 32), which is the reason I will not be here on Marik when this issue hits the stands. Lt Rhys Fairchild gives us an overview on VTOLs. We publish for your amusement the winning paper in the Halas Scholarship Competition. And the usual mix of technical information, simulator stats, and ... last but not least, your reminiscences of how the war began.

Rest up, warriors. You deserve it.

— Hilary Ayer
February, 3030
Atreus, Free Worlds League

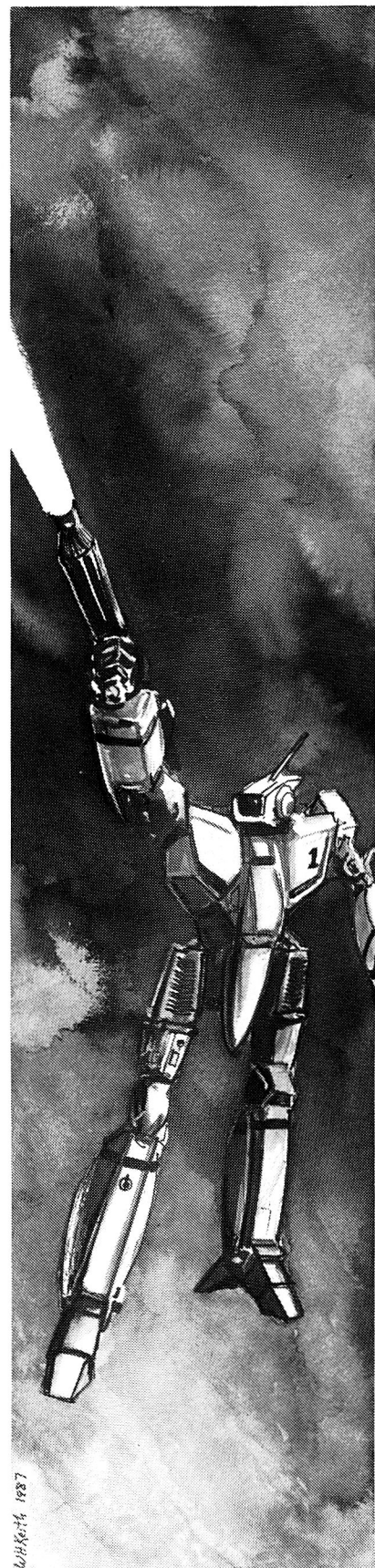

BattleTechnology

The Magazine of Combat in the 31st Century
The **only** authoritative news magazine covering the Inner Sphere.

BattleTechnology . . . Because the only good merc is a live merc — dead ones can't shop at my store!

— Abraxis (Mo) Murasaki, Owner
Battletechnic Military Salvage

BattleTechnology, with its BattleTech Simulator, is the best Mech Warrior training device I know — relaxes you after combat, and sharpens your skills at the same time. Don't leave home without it — unless you want to die young!

— Captain Mamluke 'ap Prentiss,
Drillmaster,
The Faroes' Own Independent Lowlanders

Even **BattleTechnology**, which tries to remain unbiased, has printed colorful lies about the Capellan Confederation...

—T'eng Lu,
Maskirova Official

BattleTechnology is available from finer merchants throughout the Inner Sphere, from our publishing house on New Avalon, or from:

BattleTechnology
Post Office Box 23651
Oakland, California 94623

Subscriptions are available at \$24 US in the US, \$27 US in Canada, \$48 US elsewhere on Terra.

Back issues 0101 through #7 still available postpaid at \$3.95 in US, \$4.95 US in Canada, \$5.95 elsewhere on Terra. Issues # 8 and after are \$1 more.

0101, August 3027 — report on Davion Op Galahad, MechWarrior mental discipline, FLC-4N 'Falcon' Mech, Battle of Kilgore Engine Swaps, Combat drop on Scheat V, more.

0102, December 3027 — Combat Salvage, Camouflage, Hassid Ricol: The Red Duke, Black Luthien: the Draconis capital, DVE-5B 'Devastor'

0201, February 3028 — Tharkad, Decompression, GLD-3R 'Gladiator', BattleMech Weapons — range versus accuracy, Galaina the Pleasure Planet, Vacuum combat, more.

0202, April 3028 — Hanse Davion Interview, Cavalry Tactics & Applications, Lasers, Banshee BattleMech, Dragonslayers, Battle at Wittengate

0203, June 3028 — Maximilian Liao Interview, Kearny Highlanders on Mira, Liao Edge on Solaris, Urban Camouflage, more

0204, August, 3028 — WAR BEGINS, Goliaths on St Andre, Miniatures Combat, Reports From the Front, Close Assault

#7, March 3029 — ALI-1A Alliance, BattleMech Technician, The Phransigar, New Invasions

#8, September 3029 — FLE-14, Athena, Davion Cut off by ComStar, Cobalt Coil, Blood on the Snow

#9, March 3030 — WAR ENDS, VTOLs, Beatie Hovertank Blueprint, Skyfall, Assault on Kusari, Marik Diary

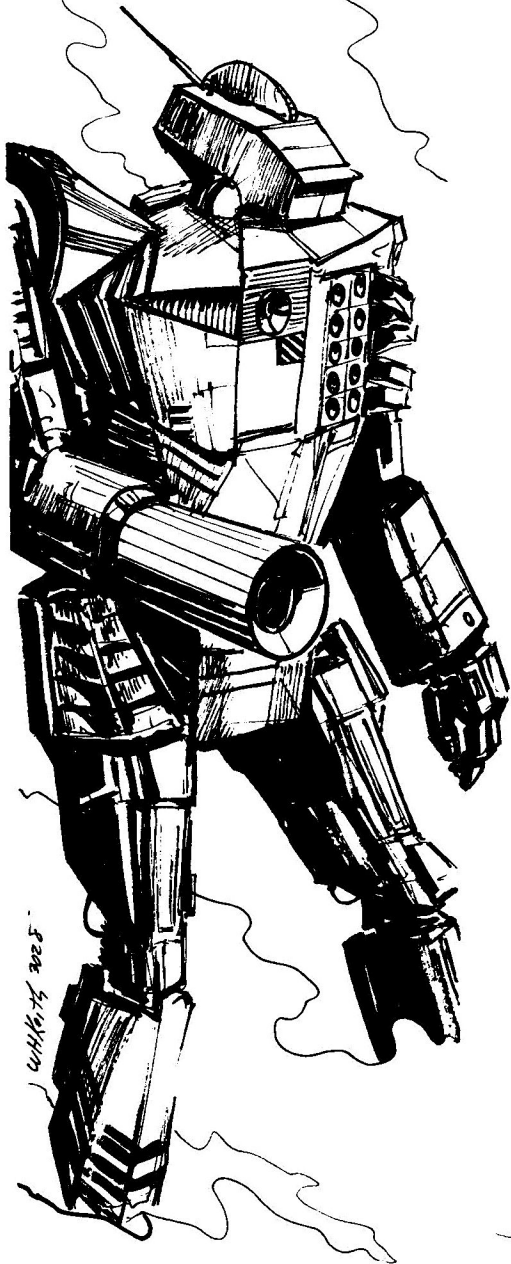

BattleTechnology News Service

Surprise, Chancellor!

Sian, Capellan Confederation, September 2, 3029

Today marked the arrival of what was supposedly the captured Duke Morgan Hasek-Davion. When the DropShip had landed, a large number of 'Mechs wearing the colors of the Lions of Davion, the First Kathil Uhlans, were discharged. They began attacking the city. Duke Morgan's 'Mech was leading the attack! It seems that not Duke Morgan, but the Capellan ships he rode in on had been captured. Throughout the day the Davion assault force laid waste to the Liao Battlemechs. These were Liao's best, which had had been fitted with the new triple strength myomer bundles (for which the formula had been stolen from Davion by a team of commandos sent by Justin Xiang earlier that year). As soon as the Liao 'Mechs heated, the myomer bundles began to break down. It seems that the formula had included a two-part chemical which causes the fiber to become shattered and useless under combat conditions. There hadn't been time yet to field-test the 'Mechs...

One of the Davion heroes was MechWarrior Hamish Shane. Piloting a Panther, he took on a group of five medium 'Mechs which had not been "improved" with the new myomer formula. Using rooftops, and a judicious use of weaponry, he was able to eliminate the Liao 'Mechs one by one. He was also most influential in providing the chance to get this news item out. He picked up the skimmer which our reporter Nelson Chang was using to get about the rubble streets and carried it back to the spaceport!

During the withdrawal of the Davion assault team, there were unconfirmed reports of seeing the Traitor Justin Xiang around the DropShip which had brought in the attackers. There were also reports of Candace Liao's presence with Xiang. These two have become very close since his defection to House Liao. Could it be that the two have played into Davion hands and been captured? Or could it be that Justin Xiang was a deepcover mole for Prince Hanse Davion? BattleTechnology promises to bring you more on this question soon.

Sentencing in Northwind War Crimes Trial

New Avalon, February 26, 3030

...Lt Kahil Holt was offered a choice of sentence; a reduction in rank, with two years public service on the planet Northwind, or a dishonorable discharge from Team Banzai. Sgt Holt chose the first alternative. With the rest of Team Banzai, he is recuperating in the royal infirmary on New Avalon after nearly losing his life in the defense of the NAIS last September. He will begin his public service this July. Team Banzai spokesmen say that his Rifleman will be held for his return.

Kell Hounds — How Did it End?

Nusakan, Lyran Commonwealth October 24 3029

Today at last the *Genyosha* met the Kell Hounds; this was to have been the culminating battle in the feud begun over a decade ago between Col Morgan Kell and *Tai-sa* Yorinaga Kurita. When the two leaders decided to settle it by duel, all action stopped. No-one moved as the skilled warrior Yorinaga ducked and wove his Warhammer, sending shot after shot into Col Kell's Archer. Morgan Kell did not return fire nor even seek to evade. None of these shots seemed to hit.

There was a long conversation on the private band. Then combat resumed, ending with Col Kell's 'Mech fallen...and *Tai-sa* Kurita's going into heat shut down. Honor was at length declared satisfied, to the cheers of both forces.

Why didn't Col Kell fire? His foe had killed his brother, and many of his men. Our reporter had no explanation, but the events are a matter of record. BattleTechnology promises more coverage — as soon as we find out what went on!

Romano Liao Refuses to Sign

Sian, Capellan Confederation February 21, 3030

Acting Chancellor Romano Liao today explained to her people why she would not sign the peace treaty signed yesterday by the other four Successor Houses.

"You are not cowards," she explained. "Only cowards would accept the wholesale ravishment of our territory. The homes of our ancestors are not bargaining chips to be cast to save us from the terrible Alliance and our less-than-terrible Allies. Our ancestors' graves demand the blood of enemies. Our enemies would exterminate their descendants. We shall not dignify their pretense of peace with a specimen of our calligraphy."

Her subjects, required to attend the public vidcasts of her speech, cheered heartily each time they heard this somewhat confused sentiment. Despite the Lady of Highspire (Duchess Romano retains the title, though the planet has been lost), the Inner Sphere is now at peace. Her war-torn planets, her 'Mech Force hampered by useless "new-style" myomers, her hungry people preclude the warlike lady from taking the revenge she so ardently desires.

BattleTechnology News Service

Sgt Holt After Sentencing February 28, 3030

Maddelena Brant, BattleTechnology Broadcast News, in an exclusive interview with Lt—now Sergeant—Holt in his hospital cell. One week later, Sgt Holt was shifted to a civilian recovery home in the countryside far from New Avalon. He is reported in good condition.

Brant: Do you think that the verdict of the board was fair?

Sgt Holt: Most fair. Especially because I'll be having a chance to do what I was arguing for; offering to assist the people of Northwind after their great losses, particularly to the civilians.

Brant: Will you be returning to Team Banzai afterwards?

Sgt Holt: Most probably. A position has been made open to me two years down the road with no prejudice.

Brant: I've promised to ask this — so many of our readers want to know. What is Dr Banzai really *like*?

Sgt Holt: A taskmaster. He only wants the best Techs and the best mechwarriors. He is...highly creative. How else to describe him? I wouldn't want to serve under any other leader.

Brant: Now you've been away from the front, and the pressures of a combat situation, do you still consider your actions on Northwind, killing Kurita soldiers who seemed ready to surrender, justified?

Sgt Holt: Yes...because they brought civilians into the war in the way they did, which is against the Ares Conventions and against what the mechwarrior really stands for. Mechwarriors fight...in an honorable way. Despite the Kurita sound, there's no other way to say it. Plague is not an honorable weapon, unless it comes by nature or by accident.

Brant: Would you do it again?

Sgt Holt: At this time I would have to say yes. Perhaps after my time in Northwind, among the most honorable warriors I know, it will be otherwise. After all, I'll be in a noncombat situation for an extended time. Perhaps it will temper me as a sword needs to be tempered.

Brant: Finally, is there anything you feel the need to say to the peoples of the Inner Sphere?

Sgt Holt: Yes. Let's see if I can say this right. No cause, whether it seems to be for good or evil, which harms noncombatant civilians can ever be justified. Honor requires that only those who have chosen the warrior's path should fight for those who are weaker — the innocents.

Day of Thanksgiving

November 16 3029

New Avalon, Federated Suns

Today a Day of Thanksgiving was celebrated, proclaimed by Prince Hanse to praise the people who have aided in the war against the Capellan Confederation. He began with the exoneration of Justin Xiang Allard, who has apparently been undercover since his trial and disgrace at Prince Hanse's own hands. The trial was a ploy to get Justin into the good graces of House Liao, as were the Solaris Davion-baiting combats which had attracted the attention of all the Inner Sphere. Prince Hanse not only gave Allard a pardon, but called him a hero of great ability, a man who had gone through incredible sacrifices beyond the call of duty.

Duke Morgan Hasek-Davion was proclaimed a hero for his daring ruse on Sian this September. His ploy of being captured by Liao troops had placed the Capellans at ease, and created an illusion of superior chances of winning against their Davion foes. When the DropShips landed, Duke Morgan's new force, the Lions of Davion, dashed all hopes that House Liao had of winning the Fourth Succession War.

After the honoring of several other men and women who had served well, the Prince announced his wife's greatest service to date. Princess Melissa Steiner-Davion had paid a secret visit to her husband during the war-torn month of July. During that visit, Princess Melissa, Archon-Designate of the Lyran Commonwealth, became pregnant. This news was the greatest of all because it meant that there was to be an heir for both the Federated Suns and the Lyran Commonwealth, the final link between the two states. Now that the war seems to be almost over, only the discussion table is left to be fought over. Perhaps life will return to normal in the Inner Sphere.

Text of a letter from Maddelena Brant, BattleTechnology Weekly News, to Bob Carter, Editor-at-Large, BattleTechnology, Sep 16, 3029

...It isn't pretty, but it needs to be told. Chancellor Liao asked his Kurita allies to trounce Northwind because the Highlanders reunited with their kin and spoiled his plans in the middle of a war. The fact that Northwind is a key planet in Davion's corridor to Terra probably had a little to do with it too!

The use of biological weapons against two major population centers is fully documented in the packet enclosed. Cromarty alone lost 1800 lives, many of the children. This is a black stain on House Kurita's wartime ledger.

...No, these atrocities do not excuse the savagery with which the battered units which had held out so long treated the Kurita losers when the tide of battle turned. Part of our balanced news coverage is surely to show the reasons why these troops felt driven to their actions.

Lt Kahil Holt is one of many. He was driven past the breaking point and he broke. He is not famous or rich enough for anyone to want to cover up for him. He's willing to do another interview, but only for us. And only if we publicize the violations of the Ares Conventions. He's not asking for mercy, but he does want to be heard.

Mr Carter, I'm interviewed a thousand sweaty MechWarriors in the last two years. I've conned fighter pilots into letting me come along for the ride on your instructions, and I've been in more bomb shelters than anyone my age has a right to. It's not just that I've paid my dues. I truly feel that telling these stories is what news is for...

Peace Breaks Out!

Interdict lifted: Peace Suggested

December 8, 3029

New Avalon, Federated Suns

Yesterday ComStar announced the lifting of the Interdict on Communications for House Davion. Today, Prince Hanse made his first call. He called Archon Katrina Steiner and suggested that it was time to offer peace terms. He received a positive response.

It is ironic that the terms on which the Interdict was lifted include a controversial provision under which ComStar is now allowed to station troops at each of their facilities in the Federated Suns. If the entirety of Davion space were not so exhausted by the war, there might have been rioting over this proposal. Instead it is met with an irritated apathy. Citizens of the Federated Suns prefer to prepare for peace.

ComStar Peace Pact Signed

Feb 19, 3030

First Circuit Compound, Terra

Today representatives of four of the five Successor Houses signed the Peace Pact so arduously worked out through the mediation of ComStar. Terms of the treaty keep borders where they are, reaffirm peace as a desirable state, and agree upon the lifting of trade sanctions between the signatories.

None of the minor provisions were challenged. The independence of the former Lyran Confederation states of the Tikinov Free Republic and the Duchy of St Ives were reaffirmed.

Reactions from the Five Successor Houses:

"The War is not over, nor will the Capellan Confederation be so hypocritical as to pretend we have ceased to fight. We are bloodied; we are knocked to the ground. We are not defeated. Capellans don't allow the prospect of death to halt them in a virtuous cause. Indeed, we'll go beyond death to gain the just revenge for the evils which have been visited upon us.

My snivelling sister, my false-born brother, with all that toady to the conquerors, had better watch their backs! And as for the Fox-Ghost Hanse Davion, may he and all of his rest uneasy awaiting our time of justice."

— Romano Liao, Lady of Highspire
Acting Chancellor of House Liao

"Peace is a wonderful thing. Watching the victors lick their whiskers and make no reference to the canary is less delightful. The peoples of the Free Worlds League will wait with interest to see how well syrupy speeches like Archon Katrina's will match with subsequent actions. We could always be pleasantly surprised."

— Janos Marik, Captain-General, House Marik

Petals strong scented —
Peace flowers in the warrior's hand
To give or withhold.
— Official statement, House Kurita

"I caused war to find peace. The peoples of the Lyran Commonwealth were as gallant as I knew they would be. Soon the baby will be born that will herald in a new generation, a generation in which peace across the Inner Sphere becomes a real possibility. I am realist enough not to claim peace is probable. But to make it possible, for the first time — that's an achievement."

— Katrina Steiner,
Twelfth Archon
Lyran Commonwealth

"Looking at you, the representatives of the planets of the Federated Suns, I am overwhelmed with what it took to bring us here; we are at the point of signing a treaty of peace, as victors. How much we have done together. How much we have given for this day. How proud I am to be among you!

Now come the responsibilities of peace. Now come reconstruction and consolidation. I ask for acceptance of the citizens of those planets which formerly belonged to other Houses as full members here. I ask for the restoration of trade as we all work together for peace's other cousin — prosperity.

I ask for nothing less than your untiring efforts at not just rebuilding — but rebirth."

— Hanse Davion
First Prince, Federated Suns

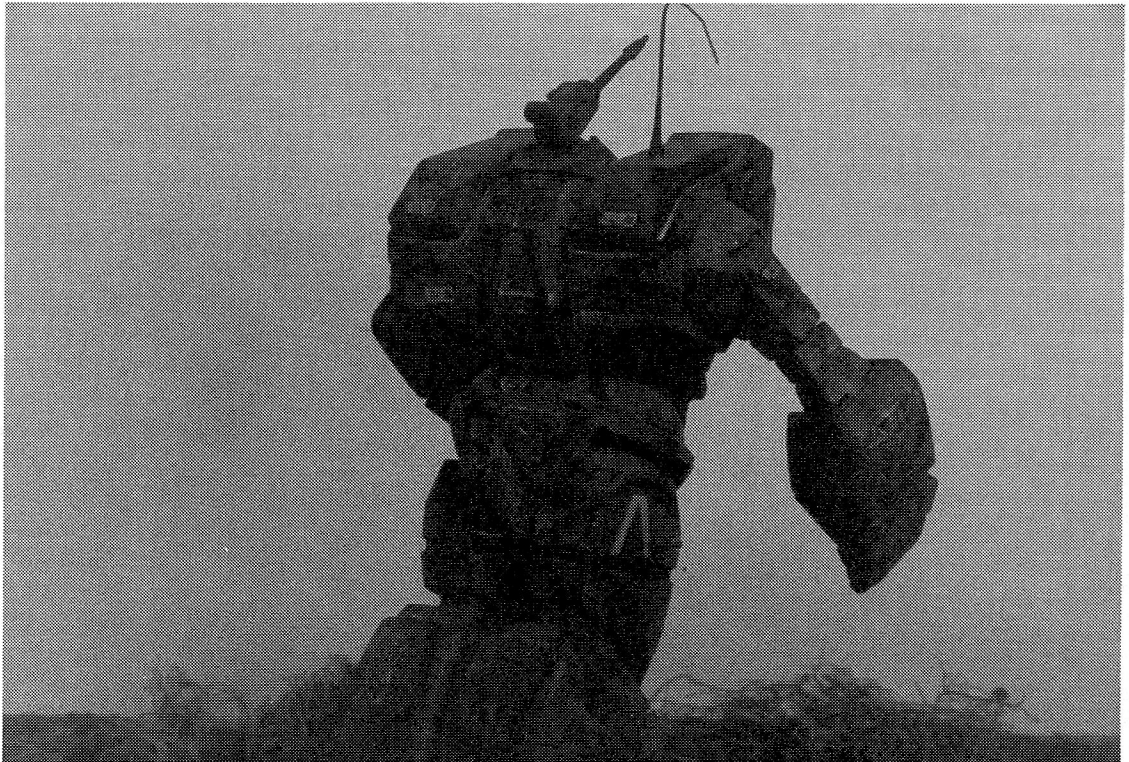

A lonely sentinel, Sarna March of the Federated Suns

.....
.....
.....
Other states of mind:
.....
.....

"St Ives is thankful and grateful. Independence and peace come together for us. What could be left to wish for?"
— Candace Liao, Duchess of St Ives

"The Tyr are not at peace until we have a homeland to be at peace in. We have fought heartily in causes which were not our own. Promises will be kept. That is not a statement of expectation. It is a statement of intent."
— Haakon Manusson, Tyr Spokesman

"Andurien wasn't consulted about the peace. Of course, we weren't consulted about the war, either. I have stood for peace with honor for my entire political career"
— Catherine Humphries, Duchess of Andurien

"The Tikinov Free Republic has been guaranteed its rights. If its citizens desire the privileges — and the heavy duties — of independence, they will be allowed to be so. Tikinov will not be sold back to the Capellans who have betrayed her at any price."

— Lt Gen Ardan Sortek
Protector Pro Tem of the Tikinov Free Republic

"ComStar was happy to arrange the Treaty of Peace for its warring children of the Inner Sphere. We will speak no more of the past. May the Blessed Blake be with you."

— ComStar official statement
First Circuit Compound News Spokesman

"It is time to absorb the lessons we have paid for."

— *Tai-sa* Theodore Kurita
Heir-Designate, House Kurita
Speech to his troops telling them of the war's end

When the Lyran Commonwealth formed its alliance with the Federated Suns, just about everybody thought that there would be an end to the war which had raged for centuries. Everybody was wrong.

Hanse Davion ordered an all-out assault on the Capellan Confederation, and the Lyran Commonwealth attacked House Kurita. Three months later the Free Worlds League, feeling that House Steiner had been sufficiently weakened, decided to attack.

Marik troops crossed into Lyran space along the border, making strong pushes at various points in their lines. One of those strong points came at Wyatt. We'd been skirmishing back and forth across the border with Marik house troops for a couple

of months, but their attack in strength caught us with our pressure suits down. Their Jump-Ships phased in at a system-rim, non-standard Jump Point. Their assault craft were halfway planetside before we even got off the ground. My squadron scrambled to intercept, of course, but it was too little too late. Their DropShips and fighters came in along the same approach path used by Major Pawaloski's ill-fated raiding force of a year and a half ago. This time, they had enough strength to force their way through and establish a plan-ahead. It fell to us to knock them loose.

There was heavy fighting going on in the veldt country, about 300 kilometers south of our airbase at Turner City. My flight was designated as fighter support for our ground forces in that sector.

In an attempt to slow the Marik advance, we treated their supply areas to a couple of fighter sweeps. I divided my flight up into air-lances and had the ground crews arm the fighters with high-explosive and inferno bombs.

The way we ran those attacks was right out of the textbooks. Alpha Lance went in low, from the west. They strafed the target. Then they laid in a couple of HE bombs. Bravo Lance went in hard on their heels, only from the south, while Charlie Lance (made up of Capt Lucas Kurtz and myself) struck last, from high altitude. We made our run from

SKYFALL

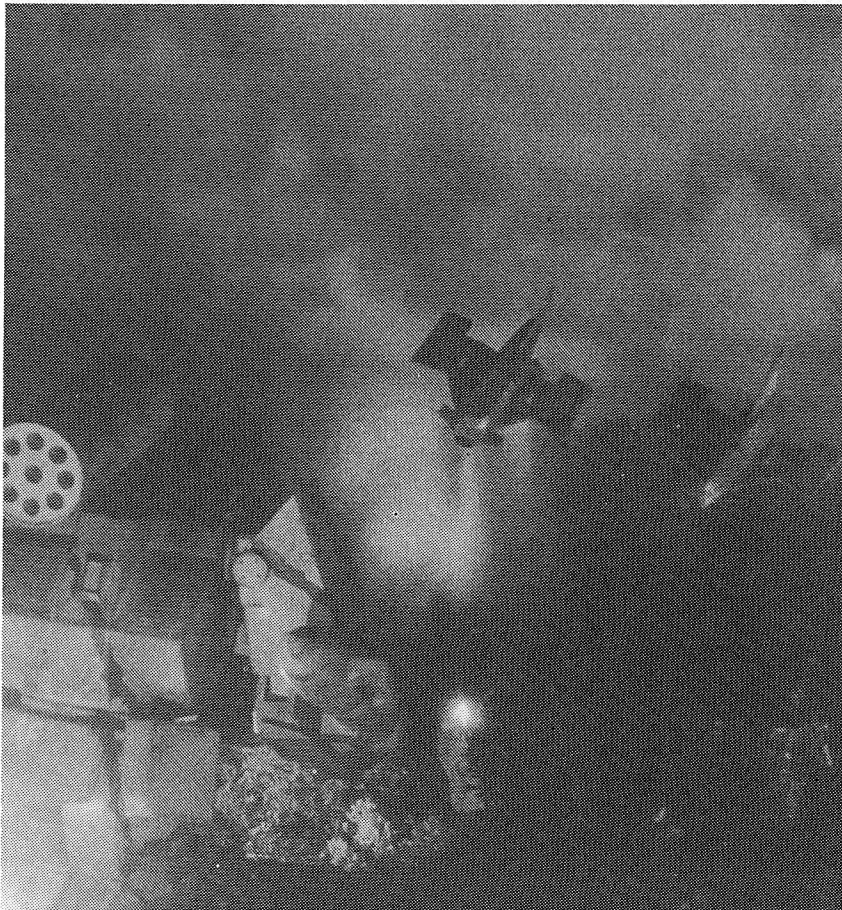

M
a
j
o
r

K
e
n
s
i
e

S
h
a
n
e
y
f
e
l
t

the west, dive-bombing with 100-kilo infernos, and then made our strafing run.

The lances not making their run provided a cover patrol for the attacking lance.

The sweeps went off beautifully. The new Chippewa fighters, which replaced our older, Davion-built Corsairs, carried a heavier weapon load. With the added firepower, we really tore the hell out of the Marik ground targets. In one pass, Kurtz took down a Blackjack and two Vedettes, then turned around and shot up a Valkyrie. Not a record by any means, but still impressive. All told, our sweeps accounted for four 'Mechs and a dozen assorted vehicles. However, that still didn't slow down the Marik advance.

I went to regimental command for permission to stage a series of sweeps against their major landing zones. If we were to run a couple of heavy air-strikes on their DropShips and planetside fighter ships, we might make it too costly for the Mariks to stay.

Regimental's reply was more devastating than a hit from a particle cannon.

"I'm sorry, Major Shaneyfelt, but Brigadier Left has just received word from Sector Command on Skye; all Commonwealth troops have been ordered to withdraw from Wyatt," Col Buckholtz told me. "We have been ordered to begin evacuation procedures immediately, and to offer only token resistance."

"What?" The clatter of my chair overturning as I shot to my feet was lost in my enraged shout. I could feel my face turning as red as my hair. "Are they daft? Are you daft? We can beat those *damanta gallda bligeard*! Why should we withdraw?"

"Because those are the orders, Major!" Col Buckholtz was on his feet now, too. "I don't give a hiccup in a windstorm about your opinion. We've been ordered off Wyatt, and by God, you're going to obey those orders!"

Buckholtz was livid. I'd never seen the old man lose his temper before, but there he was, shouting and thumping on his desk. The orders to withdraw from the planet we'd fought so hard to defend hit him just as hard as they did me.

"I'm sorry, Irish, it's just..." His voice trailed off as he sat down, shaking his head.

"I know, sir. It's a bad situation, with no way out."

The situation was, in fact, terrible. Try as we might, we couldn't keep the news of our impending withdrawal a secret. When the civilian workers on the base found out, they told their families, and soon half the population of Turner City was outside our gates clamoring to be taken off planet when we left.

I guess they were afraid of what would happen to their homes and families when the invading Marik troops took possession of Wyatt. Old stories of conquering armies looting, burning, and pillaging die hard, especially among civil-

ians.

We knew better, of course. The Free Worlds League is bound by the Ares Conventions just as much as the Lyran Commonwealth. Most civilians know this, but there are still those who view the professional soldier as a caged animal who kills for the sheer pleasure of the thing.

There are a few soldiers who are like that. They generally don't live too long. They build up a reputation for committing atrocities. A bounty hunter, or someone in their own command, greases them.

In the face of an invading army, all logic and reason goes right out the window. People panic, and no amount of talk about the rules of warfare will change anyone's mind.

Technical crews worked frantically dismantling and loading the equipment we could take with us. Engineers planted explosives designed to destroy what had to be left behind. Cooks, clerks, and programmers were pressed into service as manual laborers, made to carry boxes, crates and barrels aboard the DropShips and shuttles.

One loading bay was cluttered with barrels of paint and air compressors. Techs spray painted the ancient symbol of a red cross on a commandeered civilian Mule class DropShip. I felt a little better knowing that our hospital staff and the wounded would escape unmolested in that ship.

Such personnel as were not actively engaged in loading operations were drafted as sentries to guard the base perimeter and the DropShips. At least a dozen indigs were caught trying to stow away aboard our shuttles. The thought of a person so desperate to escape an invading army that he would hide in a dark zero-G cargo hold for who knows how long made me wonder if we shouldn't try to take them along.

My squadron flew strike after strike against the Mariks, desperately trying to slow their inexorable advance.

On paper, the terms "withdrawal with token resistance" sound easy, almost pleasant. In reality, it's a nightmare. The physical trials of such an operation are bad enough, but the mental and emotional stresses are horrifying. Feelings of helplessness, frustration, and betrayal weighed heavily on everyone. There were a couple of fights, one ending when two infantrymen actually opened fire on each other. Even normally good-natured Dieter Jurgens threw a wrench at me when I asked him how soon my fighter would be re-armed.

Finally, everything was ready. Col Buckholtz called the Aerospace Forces together for one last briefing.

"This is how it is, people," he said, with no preamble. "We have a few dozen DropShips and shuttles to get offplanet and outsystem. If everything goes according to plan, five Starlord class JumpShips will arrive at the nadir Jump Point at 03:30 hours the day after tomorrow. Hopefully, the Mariks won't try to stop our withdrawal. I guess we'll find out for sure tomorrow. We may have to fight all the way to the Jump Point.

You've all been part of a fast-pass invasion before. What we've got here is the same thing, only in reverse.

Your individual unit assignments have been given to your flight leaders. The first ships are scheduled to boost in two hours.

That's about it. Dismissed."

My flight had been assigned to provide "high cover" for the escaping ships. When the enemy fighters attacked, as they almost certainly would, our job would be to engage the hostiles and keep them off the DropShips. The general opinion was that the Mariks would try to stop us before we left the operational range of their fighters, but would let us go once we outdistanced them.

"You realize that we're going to be at the broken end of a bottle on this one," Lucas Kurtz said, as we walked across the pavement to the ready room.

"I know, Luke, but I just can't see any other way out: can you?"

"No, I can't, Irish. I just hope your luck holds out." The stresses of the past few days were plain on his Aryan features.

"So do I, Luke, so do I."

Two hours is not long enough to say goodbye to a world which has been your home for the past two years. Even as we cleaned out the barracks and ready room, memories came filtering back into my mind. Like the time Marla Entz bet a mercenary mechwarrior that she could down half a liter of Caldonian whiskey at one go.

I can still see her, as she put down the half-liter mug which she'd just drained. With a half-fuddled, half-triumphant look in her blue eyes, she turned to the merc and said, "Pay up."

The mechwarrior counted out 150 Hb, shaking his head in disbelief.

"I just can't understand how anyone can pull off a trick like that."

Entz looked him square in the eye and said, "Willpower."

That was the last intelligible, non-hostile word she spoke for the next two days.

As Marla turned to face the bar again, she passed out. Luke and I had to carry her back to her quarters.

Marla woke up the following afternoon with a hangover that would have killed a raxx. Bob Douglass, her wingman, didn't help matters any when he took a tray of food in to her on the excuse that she'd feel better if she ate something.

Not two minutes afterwards, we heard a scream of pure rage, tinged with more than a little sickness, followed by a metallic bang.

Bob appeared a few seconds later holding his head, covered with creamed chipped beef and toast.

A dark purple stain on the carpet in the pilots' quarters made me think of the time Jeff Velasquez traded a case of

Tharkadian caviar stolen from the planetary governor's home to the captain of a free trader for three cases of Altair wine.

The little Venarian came scuttling into the barracks, clutching a bulky aluminum case. Without saying a word, but grinning wildly, he ran back outside, returning with another grey metal case. A final trip yielded yet a third identical container.

"Velasquez, what the devil are you doing?" Jack Cleary asked, peering closely at one of the boxes. Then, sitting back in surprise, "Is that label right?"

"Yep. Altair wine. Three full cases of it." Jeff replied. "I traded a case of black-label Tharkadian caviar to a merchant captain for it."

"Jeff," I asked, dreading the answer, "where did you get a case of Tharkad Black Label?"

"I traded an indig a Ranger's patch, a pair of issue boots, and a Kurita officer's sword for it."

Cleary looked at me. "You want to ask him or should I?"

"Jeff, where did you get a Kurita officer's sword?"

Velasquez grinned even more wildly at my question.

"I made it."

His masterpiece of scrounging was short-lived. He had to use the wine to bribe the MPs who came to arrest him for stealing the caviar.

Over the one bottle he had left, Velasquez mourned his loss, saying that it wouldn't have been so bad if he *had* stolen the caviar. He said he'd never trust another indig.

Before the wine he'd spilled was completely dry, he'd made some kind of deal with a local involving a case of contraband cigars and a box of IC engine spares.

Even these good memories weren't free of sadness. Shortly after his wine deal, Jeff Velasquez was shot down by bandits raiding for spare parts. Marla Entz was transferred when the 10th was rotated out, while I stayed behind to take command of one of the newly arrived Aerospace Unit.

For long minutes, I sat on a desk in the ready room, fingering the small piece of twisted metal hanging on a chain around my neck. Images of a red-painted eagle and memories of overwhelming fear were so clear, after a full year, that these events might have occurred only yesterday.

So many of us had lived, and fought, and died on Wyatt. Now we were to abandon it. Such a waste.

"Attention, all personnel. Report to departure stations. Ground crews to launch stations." The PA shattered my dream-like reverie. "We have 15 minutes to departure."

I slid off the table with a sigh, picked up my flight helmet, and left the ready room for the last time.

At the catapult station, Dieter Jurgens was going over my Chippewa, making a last preflight check. The big white and red flying wing gleamed dully in the afternoon sun. I paused for a moment, halfway up the boarding ladder, and patted the

image of a striking hawk painted on the nose above the words "The Falconer."

"All set, DJ?" I asked, as I swung my legs over the edge of the cockpit.

"All set, sir," he answered as he locked down the access panel beneath which he had been working.

"Your fuel tanks are full, and you couldn't fit another missile into the bins if you had to."

"OK, then, wind her up."

"Yes, sir," DJ slid down the boarding ladder and began hooking up the converters. Other ground crewmen scrambled around hooking up the catapult and plucking the last system-check ribbons off of my fighter.

The piercing whistle of turbines, followed by the boom of the igniters, filled my cockpit, only to give way to the steady whine of the big PlasmaStar 270 engine. Looking left and right, I got, and returned, thumbs-up signals from my ground crew.

Facing front again, I watched the catapult officer as he signaled me to 'rev-up'. Obeying his nonverbal command, I slowly opened my throttle, feeding more fuel to my Chippewa's powerful engine, standing hard on the brakes all the while.

At last, the cat-officer ceased the circular 'rev-up' signal, snapped a quick traditional salute, and brought his right arm over and down, ordering launch.

A gigantic unseen hand slammed me backwards in my seat, while another bigger but just as invisible hand grabbed my ship and flung it down the launch-ramp. Thirty meters from the end of the runway, I heard and felt the snap of the catapult sheaf falling away. Pulling back on the central yoke, I lifted my 90-ton ship into the air.

Over a kilometer away, I could see the first DropShips boosting, their egg-shaped hulls balanced atop billowing towers of plasma vapor and superheated steam. In the distance, I saw black specks moving across the plains towards the spaceport. Occasionally, flashes of light dotted one of those black pinpoints. I knew that those small dark shapes were the advancing Marik units and our own delaying force. Pride and sorrow rose in me for those brave men and women who volunteered to spend their lives to gain more time for the escaping ships.

At 15,000 meters, my squadron-mates and I dropped into formation with the transports. The vast ovoid bulk of a 9,700-ton Overlord dwarfed my fighter. DropShips always overawed me with their sheer size and incredible amount of firepower. Ahead of me were more DropShips, fighters, and

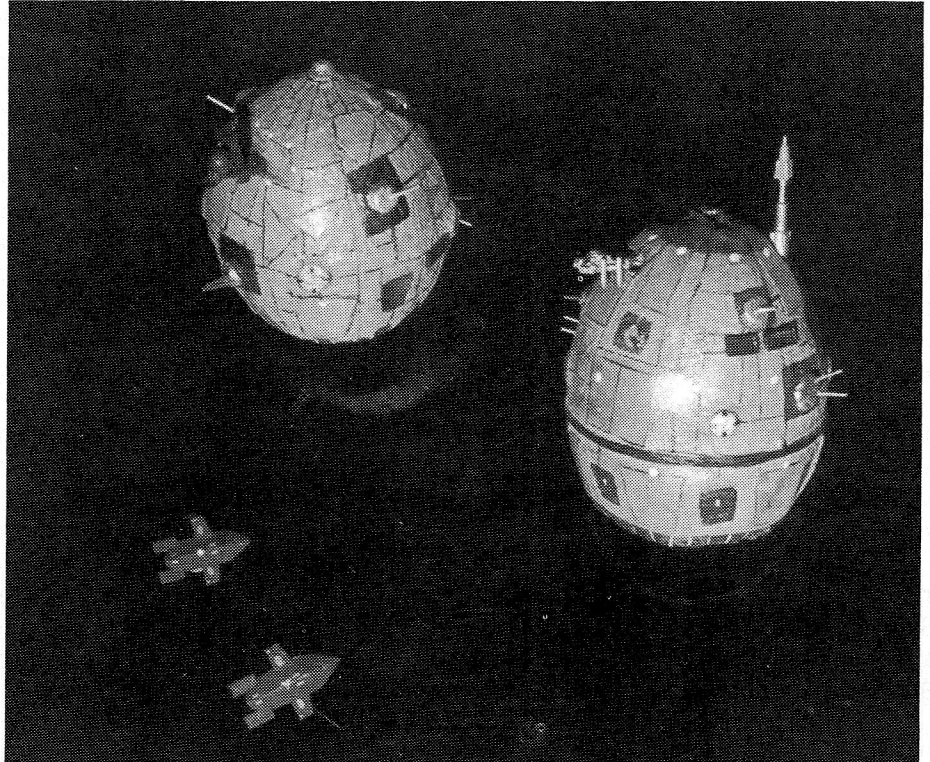

shuttles; some were visible only on my long-range scanners. All were boosting for the rendezvous point.

Radio traffic flooded my headset. A flight of Seydlitz light fighters had engaged a flight of Marik F-10 Cheetahs. The light fighters were being hard pressed. One of the Fury class DropShips carrying troops and support personnel had been caught on the ground and captured before it could boost. Shouts of rage, pleas for help, and cries of pain all filtered through my helmet speakers.

Just as we cleared the atmosphere a squadron of Marik fighters swung alongside our escaping ships. Wyatt's sun gleamed on their wings as they slowed to match our speed.

"To the commander of the fleeing Lyran forces," came the call over a wide-band transmission. "Turn your ships about and return to the spaceport. If you comply immediately, you will be treated as prisoners of war under the Ares Convention. If you refuse, we will destroy you all."

Seconds ticked by as we silently held our course. Would Brigadier Leff give in or not? The question was answered with brutal eloquence when the Overlord carrying the brigadier sent a full broadside of long-range missiles burning across the void into the Free Worlds line.

"Here they come!" somebody yelled. Suddenly, my HUD was covered with threat warnings.

"All right, people, let's go get them," I said, wheeling my fighter away from the DropShips. All along the line of our escaping convoy, other Commonwealth fighters were doing the same. All feelings of betrayal, loss, and frustration were

forgotten. Here at last was something I could understand: combat. Grand strategies and expediencies of war are of no concern to a fighter pilot, in whose mind even the most powerful drug is a pale shadow of the pure exhilaration of flight.

Bright spots flared on the noses and wings of the Marik ships as they launched long-range missiles or fired particle cannons. My own fighter shivered as 30 ExoStar long-range missiles left their tubes. At over 100,000 km, the brief flashes of exploding warheads were only visible as tiny pinpoints of light that flared and faded in less than a second.

The enemy ships were splitting off in pairs and flights to attack our DropShips or to engage our fighters. Kurtz and I turned to intercept a pair of F-90 Stingrays as they closed on a Union. Lightning flared from the Stingrays' PPCs, raking the DropShip's armor. Lasers, autocannons, and missiles struck out in reply. The F-90s looped around, intending to make another pass. Kurtz and I caught up with them.

Laser fire streamed from my wings, burning into the trailing F-90's fuselage and wings. Kurtz blasted the leader's nose and cockpit with a volley of long-range missiles. The Marik pilots, taken by surprise, split off from the DropShip and leapt upwards to challenge us.

Head-on to our enemies, Kurtz and I sent searing bolts of laser energy into the Marik fighters. A charged particle stream rocked my Chippewa as it slammed into my fighter's nose. A pair of laser shots flashed past my canopy.

Luke rolled out to the right, while I pulled around in a left Shandell turn. As the Marik fighters flashed between us, Kurtz and I dropped in on their tails, following a routine born of long practice. The F-90s went into identical right wingovers, angling back towards Wyatt. I turned to follow them, knowing without having to look that Luke was right behind me. Operating like one pair of hands, we tipped our fighters over

into a steep drive and unleashed the full fury of the heavy weapons built into the Chippewa.

The 'Slantback' which had been framed in my sights momentarily vanished in the flare of 36 exploding missiles. When it reappeared, I saw large gaps in its armor, its superstructure showing through in places. The F-90 which had been savaged by Luke's lasers and missiles had been blown in half just in front of its forward angling wings.

The damaged Stingray tried to run, but a Lucifer from Blue Squadron shot it apart after a short chase.

Luke and I looped back to the convoy, cutting across a pair of Rievers which were mauling a Leopard. Despite the DropShip's heavy armor, the Marik fighters had managed to inflict serious damage on the larger ship.

Caught between two fires, the F-100s broke off their attack, skimming across the Leopard's beam. As Kurtz and I followed them, intense shafts of light snapped from the Leopard's guns. Our fighters were bracketed by the DropShip's fire, some of those powerful bolts actually striking home on our ships.

"Steiner!" I screamed into my commlink. "We're on your side!"

Luke's impassioned transmission was less than printable.

Admittedly in the heat of battle the flying-wing silhouette of a Chippewa pretty closely matches that of a Riever. I couldn't be too hard on the Leopard's gunners.

Distracted by the friendly fire, we gave the Mariks enough time to circle back and engage us. Heavy autocannon fire hammered my tail while a volley of missiles burst against my CHP-W5's wings.

"Luke, pull around to 172 mark 5 and punch it!" I shouted as another burst of autocannon fire slid past my ship. Without waiting for a reply, I stood on the right rudder pedal and slammed the control yoke down and right.

When I came out of the tight diving turn, I rammed the throttle wide open. My transponder grid showed 3 ships behind me; Kurtz, still flying a standard scissors pattern, and the two Marik ships. Ahead of me loomed the vast bulk of an Overlord. If we could just sucker those Rievers into the DropShip's field of fire...Then, I thought, I just hope *those* gunners can tell the difference between a Riever and a Chippewa!

"Luke, follow me," I called. "Skim as close as you can to that Overlord."

"You can't possibly be serious," Kurtz's answer was full of disbelief, until a volley of short range missiles blasted his ship. "Right behind you, Irish."

Under full thrust, our CHP-W5's flashed past the Overlord, so close that Luke still swears that his starboard wingtip brushed the DropShip's hull. As soon as the huge vessel was between our fighters and those of the Mariks, I pulled around in what amounted to a controlled yaw. The high-G forces of the nose-for-tail flip would have caused me to black out if not for my pressure suit, which forced my blood to remain where it belonged, not to pool up in my legs and feet.

When I came out of that turn, I was heading straight back the way I had come, with Kurtz on my port wing. A flick of the yoke and a tap of the pedals yielded a hard targeting lock.

I slammed my hand down on my fire control panel, sending thirty missiles and four laser bolts into the lead Riever. Kurtz copied my attack, raking the second Marik ship with his own heavy weapons.

The suddenness of our attack caught the Mariks off guard long enough for us to fall in behind them. Lacking rearward defensive weapons, the Rievers struggled to shake our pursuit. Armor incandescenced under the megajoule caress of our laser, and was shattered by the brutal impact of high explosive missile warheads.

Suddenly one of the Marik ships

collapsed, broken and battered by our hammering weapons. The other tried to roll out. It was destroyed by a DropShip's PPC battery.

"Luke, you OK?" My own SSD showed moderate damage to both wings and my fuselage.

"I'm a little shot up, but I'll make it," Kurtz replied. "How about you?"

"DJ's not going to be too happy, but I'm still spaceworthy," I answered. "Can you see any of the others?"

In the end, only 6 of the 18 fighters of Green Squadron survived. The Free Worlds pilots pursued us until our spaceborne convoy passed the orbit of

Wyatt's solitary moon, destroying or capturing in the process eight of the thirty DropShips and shuttles used in the operation. Two more were captured on the ground.

Skye Command called the operation a successful rearguard action with only moderate casualties.

I call it a bloody waste. Over a thousand lives were lost, and who knows how many Cb worth of nearly irreplaceable equipment was destroyed — and for what? A tactical withdrawal. A fighting retreat. A consolidation of our force into a more defensible position.

I've heard all the fancy terms the politicians and the High Command are

using for the Wyatt pull-out. Under all the sugar coating, behind all the shiny facades, they all mean one thing: we lost at Wyatt.

As a soldier, bound by duty to obey the orders of my superiors, I can understand the reasons for the whole rotten affair. Understanding the reasons doesn't make it any easier to accept the fact that we were ordered to leave.

From all indications, it's settling down to be a long war, and I'm in it for the duration. Like most soldiers who risk their lives every day for God and country, I don't really care about expediencies or politics, but I have a message for those who do. *Next time, let us win.*

Send me _____ MechWarrior Personnel Files @ \$6.95 each. Ohio residents add 5 1/2% sales tax. Please indicate the House(s) you desire by writing the number of copies of each House in the blank next to the appropriate House name.

_____ Davion

_____ Kurita

_____ Steiner

_____ Liao

_____ Marik

Name _____

Address _____

City, State, Zip _____

Mail check or money order only to:
Shield Laminating, Inc.
PO Box 18253
Columbus, Ohio 43218

BattleTech is a registered trademark of FASA Corp. and is used under exclusive license by Shield Laminating Inc.
Copyright © 1988 FASA Corporation
All Rights Reserved

BATTLETECH® MechWarrior Personnel File

Available for each of the five Houses!

The MechWarrior Personnel File provides you with BattleTech military data documents and serves as a storage folder for all your BattleTech papers. Each file is printed in the appropriate House colors and can be personalized by you to fit your individual background. For only \$6.95 here's what you get:

- Kill Stickers
- After-action Reports
- Mech Pilot Certificate
- Colorful Storage folder
- Officer's Commission
- Letter from your House leader
- House Recruiting Poster
- Next of kin/Insurance Form
- MechWarrior Data Sheet
- Radiation Detection Badge

Available at your local game/hobby store or by mail using the order form at left.

BattleTechnology

Interviews

In BattleTechnology's continuing tradition of bringing you interviews with the most important personalities in the Successor States, we are happy to bring you this exclusive interview with Princess Melissa Steiner-Davion, First Princess of the Federated Suns and Archon-Designate of the Lyran Commonwealth. The interview was conducted over a several-day period in late April-early May of last year, and covered a whole range of topics. The interview was conducted by the award-winning journalist Brandon Corey.

BT: Thank you for consenting to this lengthy interview, Your Highness. I apologize if my line of questioning seems haphazard — I would like to keep things as natural as possible and follow up on interesting points as they surface.

Princess Melissa: That is quite all right, Mr Corey. Where do you want me to begin?

BT: Let us start with your wedding and the unusual toast your husband made. From the holovids you did not look shocked at all at his declaration of war on the Capellan Confederation. Did you know about that plan, or are you just naturally able to cover your shock that well?

Princess Melissa: I think it would be a terrible thing for a husband to start off his married life by concealing such a momentous thing from his wife, wouldn't you?

BT: I concur, but that does not answer my question.

Princess Melissa (laughing lightly): Touche. Yes, I had been made aware that hostilities with the Capellan Confederation would be taking place in the near future. I had not been told what to expect in my husband's toast. Hanse had not intended to make that announcement at that time, but Liao's having dragged Justin Xiang to the wedding, and the attempted assassination of Quintus Allard made it seem like an appropriate thing to do. So you see, the answer to your original question is both yes and yes: I knew, but I am also able to shield my shock and my emotions from others.

BT: Would you mind unshielding your emotions to tell us about the man you love?

Princess Melissa (blushing slightly): I find it hard to conceive of a finer, brighter, more courageous man existing in the Successor States. As you know, having been a MechWarrior yourself, MechWarriors are not easy to love. They always reserve part of themselves and their devotion for the machines that carry them into battle. Still, when one is willing to

share with you his life and heart, it is a very special thing.

BT: Both you and your husband left Terra the day after the wedding. Now, nearly nine months later, you are showing no sign of being pregnant. This leads me to two questions: Would not an heir strengthen this alliance between the Federated Suns and the Lyran Commonwealth? And what stresses is this separation putting on your marriage?

Princess Melissa: Certainly an heir would strengthen the alliance, and we do mean to have one as soon as possible, but right now there are other political considerations to deal with.

BT: Do you refer to the rightist element that believes your mother sold you to the Federated Suns in return for items of dubious technological advantage?

Princess Melissa (shrugs): In part, yes. More importantly, however, it is vital that the people of the Lyran Commonwealth realize that their future has not been dealt to House Davion without any consideration for them. House Steiner and House Davion entered this marriage as separate and distinct partners. While I would dearly love to be at my husband's side, supporting him as a wife should, the only way I can prove that the Lyran Commonwealth is indeed the Federated Sun's partner is to be apart from him.

To answer the second question you posed above, the stresses this creates in our marriage are incredible. Anyone who has ever been in love knows how secure and reassuring the simple act of reaching out and touching your lover can be. Hanse and I do exchange holovids constantly — diplomats complain about having to endure the trips to haul these Hermes bundles back and forth — but that hardly compensates for the lack of physical contact.

BT: Have you no plans to be together? I mean, your first anniversary is coming up and...

Princess Melissa (laughs): Why, Mr Corey, if I answer that question, Simon Johnson will have you shot as an ISF agent weaseling state secrets from me.

BT: Forgive me...

Princess Melissa: *No blood, no report!*

BT: I see your association with the Prince has already begun to have its effect upon you.

Princess Melissa: Pardon?

BT: Using that MechWarrior expression, for example. Also, I cannot help but notice you are wearing a 'Mech charm.

Princess Melissa Steiner Davion



"I want to make my new people whole again."

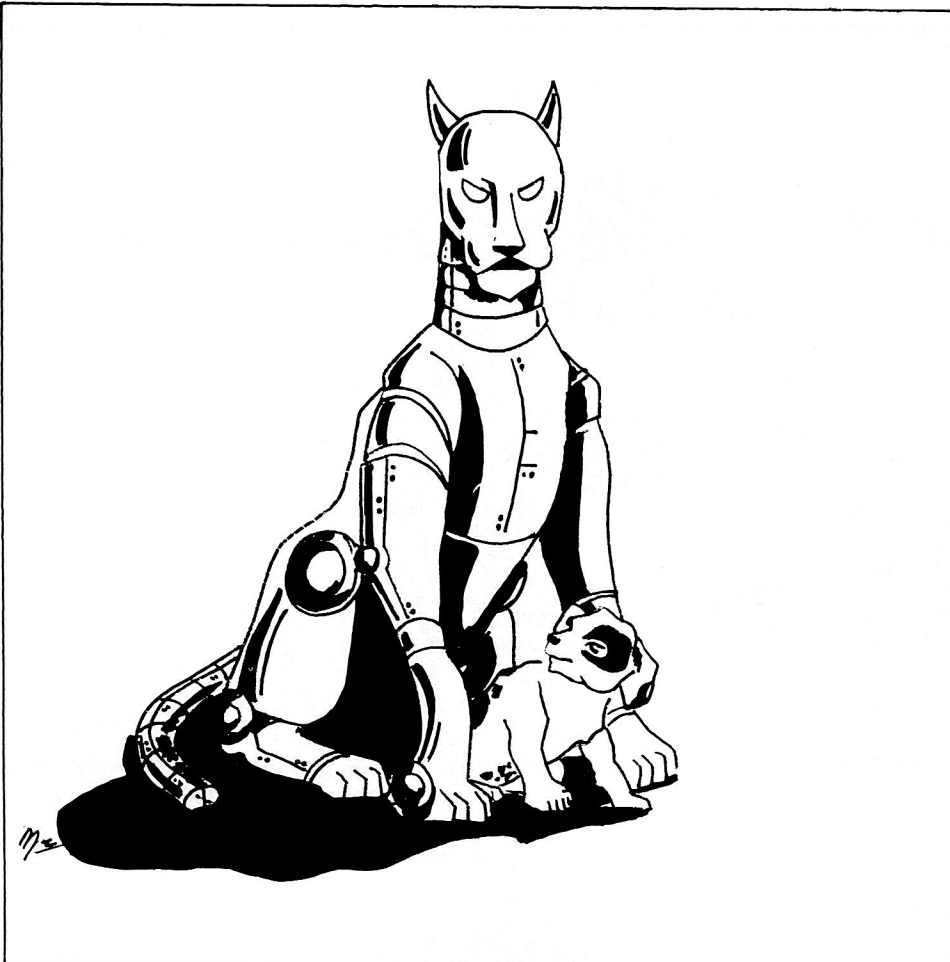

Princess Melissa: Yes, Hanse gave it to me after the Sytx incident. He said it was a piece of his first 'Mech, salvaged from when it was shot out from under him. He maintained it was an Albion tradition to give it to a loved one as it would keep them safe. I cherish it and wear it next to my heart all the time.

BT: Not unlike Sanglamore graduates and their belief in the miraculous powers of their Sashes...

Princess Melissa (frowning): I don't, oh, I do seem to recall something like that. Yes, until recently each graduating class used to send one of those Sanglamore Sashes to my mother.

BT: You mentioned the Styx incident. Until the wedding we WERE unaware that you had been on board the Silver Eagle, traveling incognito, to see your husband. Being there when your cousin Patrick Kell died to rescue the

Silver Eagle must have been very painful.

Princess Melissa: I felt like I was losing part of myself. Patrick and my father were cousins, but my father died when I was barely six months old. All I had of him were old holovids and the stories Patrick would tell me about him. With Patrick's death I felt cut off from my past.

At this point, the Archon-Designate got up and pulled a small bronze statue from a shelf. Thirty-eight centimeters tall, it is shaped like a lean hound in a sitting position. The unusual thing about it is that the hound is obviously mechanical or cybernetic in nature. Sitting nestled between its two forepaws is a wholly natural puppy that looks up eagerly at the larger hound sheltering it.

About a year after Patrick's death I

received this statue through ComStar. It arrived without any message. Dr Vanderhoff down at the National Museum of Art said the chop used to sign the piece belongs to a female artist named Takara, and that the bronze is from the Draconis Combine. Simon Johnson said he had reason to believe she and Patrick had met at least once in the past.

I am glad to have someone else who shares my grief.

BT: How do you interpret the statue?

Princess Melissa: I am glad to see it in different ways at different times. I will always see the large hound as Patrick. At times I identify with the puppy, but at other times I see things in a larger perspective. Then I see the MechWarrior image as sheltering the hope of peace in the Successor States from the baser desires of men.

BT: Your personal loss, having come so recently, must affect the way you feel about the war. You have Morgan Kell out there fighting against the Combine, and you could possibly lose another link to your father. What are your feelings toward the war?

Princess Melissa: I hate it. I hate it most of all because I know there was no way to avoid it. The strategic considerations made launching a preemptive strike against the Capellan Confederation vital. As the Federated Suns worked to recover more *lostech*, the Capellans would realize that they were falling further and further behind. Maximilian Liao, in his paranoid state, would have to launch a strike on the Federated Suns.

This being the case, and all the analysts — both public and private — said as much, it became imperative that we control the flow of the conflict. Liao had to be hit and hit hard. By doing that we could minimize casualties in the civilian population, and this is exactly what we have done. Were we the bloodthirsty bandits Liao claims, we never would have negotiated a peace that liberated the people of the Tikonov Free Republic.

BT: Your point is well made concerning why the Federated Suns went to war. Why, in your view, did the Lyran Commonwealth have to strike at the Draconis Combine?

Princess Melissa: At the time things were being planned, no one had any idea of how badly things were going between Samsonov and Jaime Wolf. The situation we were looking at had Wolf's Dragoons and the Ryuken poised to fall on the Federated Sun's Draconis March. A diversionary strike at the Dieron Military District made perfect sense. Likewise it made sense to help the people of the Rasalhague district to gain their freedom.

BT: Had you had a good picture of the animosity between Samsonov and Wolf would the plan have been altered?

Princess Melissa: (shrugs) I am not certain. You must understand, Mr Corey, while I am privy to discussions of policy and free to offer my opinion, I am not the Archon. I should add that with these difficult decisions, I am very glad I do not have that responsibility yet.

BT: Responsibility is a good topic to address. Within the context of the war and outside it, what do you see as your responsibilities right now?

Princess Melissa (laughs): You mean other than doing interviews?

BT: Touche again.

Princess Melissa: Within the war context, my responsibility lies in one very vital area. It is up to me, through work and personal sacrifice to show our citizens that we must help one another through this difficult period.

BT: This, then, would be your motivation for the rehabilitation work you've taken to doing one day a week, right?

Princess Melissa (serious): That is absolutely correct. The men and women who are medivaced all the way back to Tharkad for medical treatments have given so incredibly of themselves—spiritually, mentally, emotionally, and physically—that I cannot but honor their sacrifice by working with

them. I sincerely regret only being able to give one day a week to that cause, but there are so many other things that demand my time.

BT: How so? It seems to me that the Archon-Designate of the Lyran Commonwealth and First Princess of the Federated Suns should be able to do what she wants when she wants.

Princess Melissa: If only that were true. The problems that I have to deal with are so vast, and my contribution so small, that I wonder if I am doing any good at all. You see, the old saying, "Out of sight, out of mind," is incredibly true, especially in a time of uncertainty and possible danger. I understand how people turn in and focus on themselves and their close family or friends. It's my job to remind them that they are part of a larger community and that if they are not on the lines with a weapon in their hands they have to help by doing something at home.

For example, the refugees from the Styx base that sheltered me when the Combine tried to capture the Silver Eagle are trying to build themselves a home on the world of Lyons. Those people fled an asteroid base that had been their home, and they escaped with virtually nothing. I hosted a party in their honor, and all the newsvid networks picked up on their story and reported it heavily. Contributions of all sorts were made in their name and those people soon had what they needed to build a viable community.

That's just one example. Every day and night there are gatherings for orphan funds and emergency relief efforts. All I can do is to shake some hands and pose for some pictures, but if that reminds everyone that we are in this together, then I take some satisfaction in that. Working with the wounded, on the other hand, is deeply satisfying because I can help them recover to a point where they will be able to share the future I want to offer them.

BT: There must be times when your duties are less grim and somewhat

lighter. Have any of your subjects in the Federated Suns made demands upon you?

Princess Melissa (grinning broadly): Yes, there are light spots in my day. I received a holovid from a Baroness in the Federated Suns. She requested my assistance in a delicate affair of the heart.

BT: Can you give us details?

Princess Melissa (Feigning shock): I thought BattleTechnology better than the tablevids...

BT: You *have* piqued our curiosity.

Princess Melissa: Well, she has a certain romantic interest in a MechWarrior who is a Captain with the Kell Hounds. The Baroness thought I might be able to intercede on her behalf with this officer and get him to act like a gentleman. Apparently he is a noble, related to someone high up in the Federated Suns government, but he was seen spending time at my wedding with, of all things, a commoner from the Lyran Commonwealth.

BT: Shocking conduct for an officer!

Princess Melissa (smiling): It is well you should think so; he graduated from the New Avalon Military Academy in your class—the class of 3015.

BT: There's only one guy from my class in the Kell Hounds...never mind! How did you resolve the situation?

Princess Melissa: I'm afraid I've failed at my first request from one of my new subjects. I had to tell her that Morgan Kell had broken the Hounds' contract with the Lyran Commonwealth and that it is acting as a free unit. Therefore, I have no control over the actions of Morgan or his men. I did promise, however, that if I had an opportunity to speak with this officer and alleged gentleman, I would carefully plead her case.

BT: Morgan Kell's having taken his unit independent seems to parallel the situation with Wolf's Dragoons over in the Draconis March. Do you think this is a trend among mercenary units? Do you support it or does it worry you?

Princess Melissa: I can see how you discern a parallel between Morgan's action and the dissolution of the Dragoon's contract with House Kurita, but there is a vast difference. The Kell Hounds are not being paid by the Lyran Commonwealth — though my mother would gladly underwritten their efforts — while the Dragoons are being paid and supplied by the Federated Suns. I do not see this independence as a trend mainly because most mercenary units cannot afford to be without an employer for very long. Morgan pursues a course that is personal, and he is willing to accept the costs of that expedition.

As for my possible support for a trend, I would trust Morgan Kell or Jaime Wolf at the head of an independent company, but not so many of the other mercenary leaders. When money gets tight, some companies might resort to outright banditry — especially given that Max Liao won't be around to issue them the equivalent of privateer's papers to legitimize their crimes.

BT: I see. Let me back up here for a moment. You mentioned your vision of the future. Would you like to share that with us?

Princess Melissa: I want to see a universe in which we don't have to resort to combat to settle our differences. This does not mean I want to see a return to the Star League because, as we saw during its existence and after its downfall, it did nothing to change mankind into a more peaceful race. I long for a future where we can share our resources with each other instead of having to steal them, so no one side will have an advantage over another.

BT: That sounds very much like the message of peace and unity that ComStar pushes.

Princess Melissa: The ends might be the same, but I see worlds of difference in the means used to gain those ends. ComStar harkens back to a simpler time. They see strife as a byproduct of the complexity of our current society. To them technology seems a catalyst for discord. I must admit, if one looks at how wars are waged unevenly until both sides are battered back into a similar level of technology, ComStar could be right.

My dream, however, is to see a time when technology is freely shared. Let us turn away from building weapons and work toward building those things that increase the quality of life for our citizens.

BT: There are those who would point out that military research and development often spin off products that prove valuable to the general population...

Princess Melissa: I acknowledge that may be true, but when was the last time laser research cured a genetic disease? When did the last PPC project create a fertilizer that turns arid land into a lush garden? If we put our technology to use solving the basic problems of the universe — having enough food and freedom from illness and hardship — we won't need wars to decide who owns what resources.

BT: Yours is certainly a compelling vision of the future, yet the war itself seems to contradict or even to fully negate it.

Princess Melissa: Hardly. The Capellan people are not free to imagine a world without strife. Subjugated as they are, they cannot have dreams, and they cannot work to make those dreams come true. Man has forever proved himself hardy enough to adapt to the most adverse conditions. Once he has adapted, he has made things better. The war will liberate plenty of people and give them the chance to make their world better.

BT: You are obviously passionate about your vision of what is to come and about your husband. It must be difficult to see him and yourself vilified in scandalvids and even some of the more prominent magazines. The Prince's critics, like Michael Hasek-Davion and Justin Xiang, have been most vocal in their criticism.

Princess Melissa: That is very difficult for me to deal with because I don't have access to the people spouting lies about my husband. I regret Duke Michael's death because it meant that the distorted impression of his relationship with my

...if I had my wish, this would be the war to end all wars.

husband would never be corrected. It is a pity because, as can be seen in the excellent relationship between Hanse and Morgan Hasek-Davion, there is no great animosity between the two houses. Duke Michael might have been prone to making intemperate remarks, but the press blew them utterly out of proportion.

Justin Xiang, on the other hand, is a quisling. His statements can be weighed on that scale and discarded as garbage immediately. The man planned to betray my husband and his own nation, then complained bitterly when caught at it! I consider it a stroke of our good fortune that Maximilian Liao seems to have forgotten that Xiang *failed* in his attempt to become a spy. His having elevated Xiang to the position of spymaster is nothing but proof of Liao's dementia.

BT: What would Xiang's having escorted Liao's heir-apparent to your wedding be proof of?

Princess Melissa: Insanity is hereditary?

BT: Back on the home front, there have been some vocal critics of your mother's policy and your marriage. Duke Frederic Steiner and Duke Aldo Lestrade come to mind as the two most outstanding examples of those critical of the current war.

Princess Melissa: I have come to believe actions speak louder than words, Mr. Corey. Duke Frederick, while claiming he opposes the war, has ever been with the Tenth Lyran Guards as they spearhead the assault against the Combine. To paraphrase the Bard, methinks he doth protest too much.

We all know he has ambitions to become Archon and his success in the war can do nothing but bring him closer to making that dream a reality.

BT: What about Duke Lestrade?

Princess Melissa: I see him as a chick still trapped within an egg. He is confident he is the master of his universe, but someday he will discover that there is an even bigger and colder universe outside his warm little home. I fear for Duke Lestrade this will be a rude awakening.

BT: We've heard rumors that Lestrade ordered the Kell Hounds to vacate the world of Lyons. This would almost completely denude the Isle of Skye of troops with direct loyalty to the Archon. Speculation suggests that Lestrade will take the Isle of Skye independent, perhaps with Combine backing. Any comment?

Princess Melissa: No, not really. I think Duke Lestrade is smarter than that, but he has ached for independence over the last twenty years. Now, heirless, he might be desperate enough to grasp at straws. Still, thrusting his realm into the Dragon's mouth is not something a sane man would do.

BT: The current hostilities are nearing their first anniversary. How much longer do you see the war going?

Princess Melissa: Once again you put your life in peril of the LIC in asking me to answer that question. I think it is safe to suggest that the war will progress until the Capellan Confederation is eliminated as a threat to the peace and stability of the Successor States. At their present rate of collapse, I cannot see the war lasting more than another two or three years.

BT: Is this the war to end all wars?

Princess Melissa: If only it could be...I share with all your readers and the people of the Successor States an absolute

horror of war. I know the scars this war is making on worlds and on people will never heal again. Consider it: the average lifespan in this day and age is over one hundred years. That is incredible, considering that we send many of our best and brightest young people to die in war. That number also means that some people who are maimed in this war will have a century to live within the shattered remains of their bodies. That is unforgivable.

Yes, if I had my wish, this would be the war to end all wars. I hope and pray my children, and the children of all those involved in this conflict, will never have to fight in a war. On the other hand, I hope we will never grow so complacent that we cannot defend ourselves when the time comes.

BT: I hear in your voice a fierce devotion to making certain your people have the benefits of personal freedom.

Princess Melissa: That is because I feel that all people deserve the chance to make the most of themselves. This is why I support the war, as horrible as it may be, because it gives the citizens of the Capellan Confederation that chance. While I might well agree there are some who abuse their privilege and do not act in unison with our goals. I would sooner put up with that sort of opposition than tolerate the methods needed to suppress it.

BT: What is the first thing you want to do when the war ends?

Princess Melissa: Before or after the month in seclusion with my husband?

BT: Ah, after.

Princess Melissa: I want to rebuild. Remember, Hanse Davion gave the Capellan Confederation to me. I will make my new people whole again.

We do not wish the interview to be redone. You may call it a whim, but I find it inexplicably moving to read. Let it see print as it is and stand as a record of a terrible valiant time in our history, when the outcome was uncertain and our peoples' spirits shone forth through adversity.

Yes, the references to Minister Allard's son Justin, and to the Duchess of St Ives are incorrect and unfair. Let them stand, too, as a record of just how convincing Justin Xiang Allard was as a disaffected turncoat. He certainly fooled us. That young man should go far.

Melissa accedes in this matter to my wish that your readers across the Known Sphere get a clear picture of an extraordinary young woman working at difficult and sometimes dangerous tasks in a spirit of intelligence and optimism, giving her people hope when sometimes she felt none. Reading over the text of Mr Corey's interview, my love and admiration for that woman well up all over again. Remember, at the time of that interview, on many worlds she would not have been considered old enough to vote...

I should add that mother and child are doing well, according to all the doctors. I look forward to being a grandmother. The birth is expected in early Aptil.

Katrina Steiner, Archon of the Lyran Commonwealth

**From the Memoirs of
MechWarrior Sandusky Sorrell**

Assault on Jump-Station Kusari

Desperately, I took careful aim at the Enforcer and jumped in near-perfect "death-from-above" style...

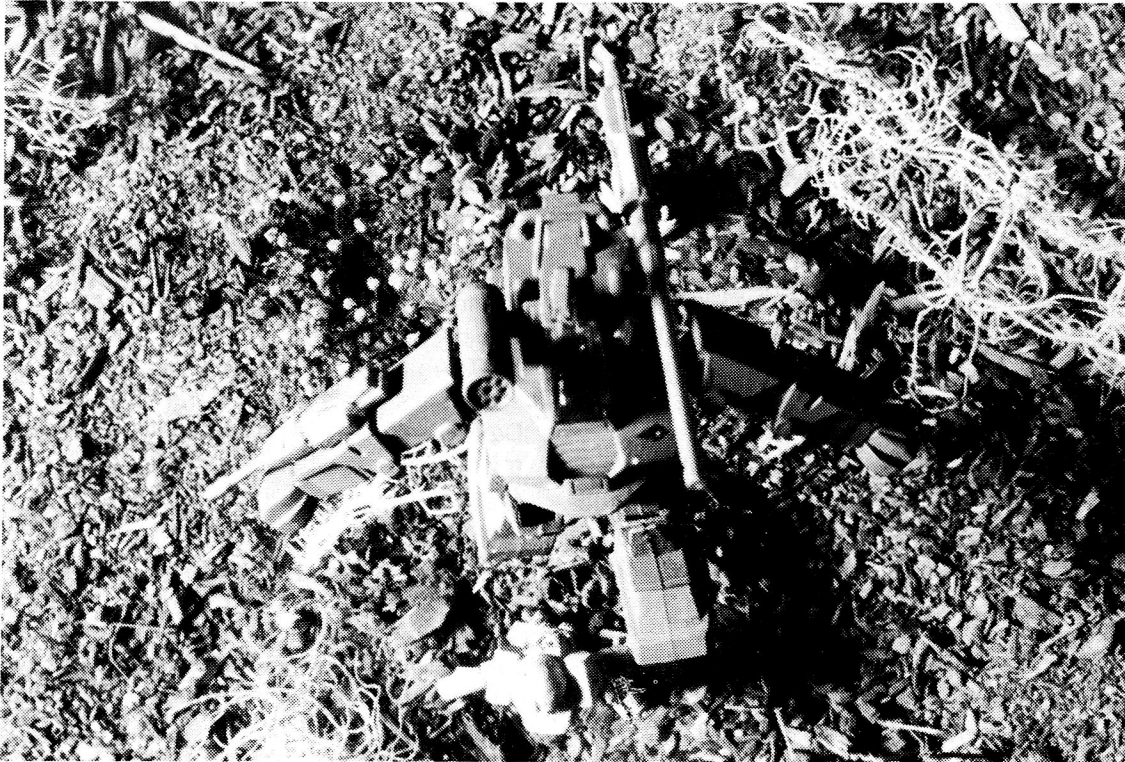

*Twin lasers blaring, 'Mechs fight to the death
House honor at stake, but — but...now what?
Death poses a real problem.*

I know — I'm a fair judge of the subject. As a MechWarrior, I face it every minute I'm on the battlefield. If things go well, I inflict death on others; if things go very, very badly, it is inflicted on me. So far, I'm happy to report things haven't gone that badly, though it has been very close a time or two.

But to a poet, death is another problem entirely. There isn't much the word "death" rhymes with. I mean a true rhyme, a genuine rhyme. I don't know any MechWarrior named "Beth", and as for the antiquated name of "Seth", that seems to have fallen out of common usage about a millenium ago. Sure, there are "heath" and "teeth" and other sight-rhymes and near-rhymes, but that's cheating. And since I don't write with a "lithp", I can't help but make a "meth" out of the whole "death" thing. Maybe I should give up writing poetry. It is such a morbid hobby anyway. Besides, I can't give up being a MechWarrior; that's what I am. At least when I am piloting my SHD-2H Shadow Hawk, the Gopher Baroque, I am doing something meaningful. And that's more than I can say for the last three hours,

which I've spent staring at a single line of an unfinished poem. Disgusted, I tossed the pocketcomp on my desk and stood up to leave. A walk in the open air of a warm late afternoon might help clear my mind.

Then came a knocking at the entrance. It wouldn't be Ludmilla Janonka, my lance leader; she wasn't that polite. It also wouldn't be Robyn, my wife, who knew better. Nor was I expecting anyone else, but then one never knows. I swung the door open and stared into the eyes of a stranger.

He was a stocky man of medium height, younger than I, with a broad crocodile smile. He bowed ever so slightly and I returned the gesture. "You are Sandusky Sorrell, Honorable MechWarrior?"

"I suppose I am," I replied indifferently. Modesty prevented me from vouching for the honorable part, but everything else fit.

"Permit me to introduce myself. I am Toki Hoshiyama-Jones." I didn't say anything and he continued after a considerable pause. "I am sorry, but does this name mean nothing?"

"I'm afraid not, Mister —"

"Hoshiyama-Jones, Mr Sorrell. An historian for the Draconis Combine. I have just been assigned to write a detailed unit history of Galt's Grenadiers." Oh-oh.

I gestured for him to come in as I hastily cleared off a second spot to sit. Hard copies of rough drafts were scattered from Terra to Star's End, and I apologized for the mess. He glanced only fractionally at my papers and took no apparent notice.

"What more can you tell me?"

"I have spoken to Major Galt of my project," he began slowly. "During the next six to nine months, I will accompany your unit in rear areas, ask questions, receive candid answers, and compile facts. Then I will leave to write an official unit history for the archives of House Kurita."

"Sounds ambitious. Where would you like to start?"

He looked at some notes on raggedy-looking flexcards, an old-fashioned dyestylus at the ready. "First, with brief personal descriptions of everyone in Galt's Company. Second, with an analysis of the unit's organization, equipment, and combat capabilities."

"What do you mean, personal descriptions?"

"Your impressions, Mr Sorrell."

"Sandy. Call me 'Sandy'."

He made another note. "Thank you, Sandy. And please call me 'Toki'. Your thoughts on every MechWarrior in your company. Feelings among lance-mates, whom you like, whom you dislike, character traits both positive and negative."

The hairs on the back of my neck started prickle. "Hmm. I'm not sure this is a good idea. Why ask me?"

"Do not be concerned. Before I am through, I will be asking everyone about everyone else. Major Galt merely suggested that I start with you. An objective observer, he said you are." That sounded like something the major would say. I relaxed slightly.

"When did you want to start, Mr Hoshi — Toki?"

"What are you doing this evening?" He stopped grinning.

"N-nothing," I thought quickly. The poetry could wait, of course, but I wanted to confirm this person's story before I expressed any further opinions. For all I knew, this smiling type might be an agent for the ISF, House Kurita's pervasive and less-than-magnanimous secret police. It would not be unlike them to use such a tactic for ill purposes. In the few years Galt's Grenadiers have been under contract to the Draconis Combine I had almost grown accustomed to political intrigue, espionage, and double-dealing. But I had never grown to like it, and neither had Major Galt. "I would like to talk with my commander before I begin —"

"Ah, yes," he said, shuffling through his notecards and extracting an odd-sized one which clearly didn't belong. It turned out to be a sealed envelope which he passed to me. "I believe this is for you, Sandy."

I gave him an odd look which he ignored, and tore the envelope open. It was a very brief note, written in Galt's own unmistakable hand: "Sandusky, T H-J chks out so far. Ops within I S freely discussable. A good man he is, son. JG." The paper bore Galt's personal watermark, proving it authentic without question.

Though the message seemed abruptly cryptic, it told me plenty. Galt had already begun checking Hoshiyama-Jones' background and hadn't found anything negative. Yet. That also meant that Galt was still looking. In the meantime, I could discuss most of the events from the Grenadiers' past while under contract within the Inner Sphere; any excursions into the Periphery were to remain our own business. Finally, upon meeting him, Galt thought Toki could be trusted for now. Perhaps the most meaningful pieces of information came from Galt's use of my formal name and this reference to me as "Son," a technically inaccurate term he uses with great rarity and deliberation. Then I noticed the first letter of each sentence: S-O-A. Stay on Alert, shorthand for "watch yourself".

I smiled inwardly. Lord Kurita wasn't the only one skilled at playing games of intrigue, when necessary. "Well, Toki, that clears up my questions," I said smoothly. "We can begin right now, if you like." His smile was answer enough.

How does a person explain the entire soul of another person to a curious but ignorant third party? That person's hopes, dreams, fears, strengths, weaknesses, talents, failings, all that which makes a person unique, in fifty words or less. Someone who has fought by your side and perhaps saved your life once or a dozen times? It's not easy for me; Miguel Castillo does a better job at such an oversimplification. Miguel is not foolish, he simply prefers to believe that the universe is an uncomplicated place except when he is forced to accept the contrary. I envy that in him; he will enjoy talking to Toki.

"This won't be easy," I admitted slowly, "but I might as well begin the lance I'm in: the Fire Lance."

"Please do," Toki prompted gently, stylus in hand.

"Lieutenant Ludmilla Janonka is the lance leader, she's commanded it since late 3022 when Lt Mikhail Gorodny left Galt's Grenadiers and Lt Jacobs became company second-in-command. She pilots a Quickdraw. I'm assistant lance leader, since I was transferred in May of '27."

"Where were you before that?"

"Oh, in the Command Lance with Major Galt. Anyway, Janonka is one tough lady, a tall curvaceous brunette with a muscular build. She can probably beat three out of any four average MechWarriors, male or female, using their choices of weapon — wit, fists, firearms, or 'Mechs.

would suffer freeze burns as a result. And she has a strange attitude. Every time anyone gives her an order, Galt or Janonka usually, she obeys — but I get the feeling she's been laughing at us, deep down inside. And I know she's only been with us for a little over a year, but she is a really poor pilot and gunner."

"You mention appearances. This lance sounds like a very attractive group of MechWarriors."

I laughed aloud, then got glasses, and a small bottle, and poured drinks for both of us. "It is. I'm the ugliest person in it."

Toki grinned quickly, then jotted a few more lines down after taking a glass.

"Then there is the Recon Lance," I continued. "Lt George Bester, a Locust and kind of shy in camp, but a real panther on the battlefield. He loves to run his

Toki commented casually.

"Oh, yes. He's a little calmer now that he's getting older, but not by much. Still, he spends less time in stockade than he used to."

Toki observed, "I do not mean to criticize, but having a 'Mech as slow as a Shadow Hawk strikes me as a rather unusual component for a Recon Lance."

"Crazy Jack is sort of a troubleshooter, when he isn't causing trouble. A Locust, Stinger, and Phoenix Hawk do not offer a lot of firepower, and all of the other 'Mechs in this company are slower. So his 'Mech is nominally attached to the Recon Lance if speed isn't so important. In other circumstances, he may likely be attached to the Fire Lance; it just depends on the tactical situation."

Toki chewed on the end of his stylus. "Hmm. You are in the Fire Lance and your wife is in the Recon Lance. Is this not an inconvenience?"

"Yes. Yes, it is. When I was transferred from the Command Lance to the Fire Lance, Crazy Jack was transferred from the Fire Lance to the Recon Lance. I asked Major Galt why we couldn't swap duties so I could be in the Recon Lance with Robyn. I made a most eloquent plea and we had a lengthy discussion on the subject."

"And?" Toki leaned forward.

"I lost." I laughed abruptly after taking a long pull on my drink. "The major refused to put us in the same lance on the grounds that our close proximity might cause either of us to disobey orders during the heat of battle, simply to protect the other. If Robyn were in trouble, for example, I might do the wrong thing, tactically, just to rescue her. Emotion versus logic, and logic had to win where Galt was concerned."

"A hard man."

"But a fair one," I countered, somewhat defensively. "John Galt saved my life, even when by all rights he should have given me up for dead."

"Sounds like an interesting story."

"A long one, too."

"That leaves just one lance," he said.

"Right," I answered, "The Command Lance. Major Galt has a Warhammer, as does Nicholas Nakamura. Captain Bodo Jacobs pilots a Crusader and Miguel Castillo pilots an Ostsol."

What if the Davions get there first?

She doesn't always believe in fighting fairly, but she does believe in winning. And she's an excellent 'Mech gunner."

"Sounds like you don't like her very much."

"No, I honestly don't," I grinned. "But I do respect her."

I leaned back. "Then there's Malcolm Wingu, a slender, hickory-skinned Trebuchet pilot, a really good-looking guy. He is pleasant, soft-spoken, and exceedingly polite, a good friend. He's also a fanatic about ancient history, claims he can trace his own ancestry back almost fourteen hundred years when his forebears were African kings, even before they moved to the Americas."

"Excuse me...Africa?"

"A continent on Terra, or so Malcolm says. I've never been to Terra."

"Neither have I," Toki added, "just curious." He continued to scribble.

"The last in my lance is Kali Konishi, medium of stature and delicate of feature. She has a Dragon." I didn't say anything for a moment as I collected my thought. "It's sort of funny."

"Kali reminds me a little of a porcelain doll, beautiful, yet hard and dangerously cold. It's as if somebody touched her they

'Mech maxed out, evading enemy fire by presenting himself as a difficult target.

My wife, Robin Fielding-Sorrell, is a Stinger pilot and a natural-born flirt. Malcolm calls her a 'short, buxom serving wench', a joke we share which has to do with Terra's early Middle Ages. There's a little rivalry between us because she's a better gunner, but I'm a better pilot. Keeps things — taut.

Ana — that's Anatole Dash, but most everyone calls him Ana — has a Phoenix Hawk. He's short and rather dumpy-looking, but he fancies himself as a gallant nobleman and ladies' man. Underneath his penchant for exaggeration and a flair for the dramatic, Ana is an untiring perfectionist. That is, in everything except his own affairs; he still has a lot to learn about handling a 'Mech.

The fourth member of the lance, and the company's other Shadow Hawk pilot, is 'Crazy Jack' Deever; he didn't get that nickname from the way he parts his hair. He loves the snap-shot, firing immediately after calculating an initial trajectory. There is nothing he likes better than a hot firefight while he laughs hysterically over the radio."

"Sounds like a very unusual fellow,"

Nicholas (or Nick-Nack, as we call him) joined Galt's about two years ago. Before that he served with a Kurita Sword of Light regiment. Apparently he had a clan dispute with another MechWarrior, someone named Wilk. Galt accepted him after Ken Tong got married and left the Grenadiers. That surprised me, because most Sword-of-Lighters tend to be a little more politically motivated than John Galt approves of. Nick-Nack was different, more conscientious than most — not a great pilot, but he tries hard. I guess he reminds me a little of myself when I was younger.

Miguel Castillo was my first friend when I joined Galt's. He used to have a Rifleman, but had it shot out from under him in 3026. It was either an Ostsol or join the Dispossessed; what choice did he have? He's a devil-may-care kind of fighter, but he will unflinchingly dive into a melee to pull out a friend. Sometimes he plays dead on the battlefield, then makes a killing shot when least expected.

Captain Bodo Jacobs, the second-in-command, takes charge of the company when Galt is away or personally leading another company of the Grenadiers. Jacobs is cool under fire, rarely raises his voice, and is about the closest thing to a robot I've ever seen in a human warrior. I'm not sure if he has any close friends, but he is a solid leader and would probably warrant the command of his own battalion in any other mercenary unit."

I leaned over and refilled our glasses, then said nothing.

"What about your commander. Who is John Galt?"

"He's a man who leads a battalion of four 'Mech companies and supporting units. He's a man who broke a high-paying contract with the Federated Suns over an affair of honor — because of the way they mistreated and plotted against one of his MechWarriors. He's a man who saved my life, and nearly took it in the bargain."

"Sounds like another long story," Toki said, sipping slowly. "And what about your real family?"

I sat up with a start; that was one question I had not expected, though I certainly should have.

I thought about it for a moment, as objectively as I could. My father, Dayton Sorrell, once a powerful man controlling

the DropShip facility on Kathil, dead these past five years (or is it six now?). My cousin Columbus, who schemed to steal a family fortune — and succeeded. My younger sister Xenia, perhaps the most beautiful woman I had ever known, who fell in love with the one man to whom I owed everything — but her. My family.

"My real family?" I knew I spoke the words, but I couldn't recognize the voice as my own. "I just told you about my real family, Toki. The others don't matter anymore." Except Xenia, one small corner of my mind screamed. "Galt's and my wife Robyn are the only family I have."

The complement of Galt's Company, Toki and myself included, gathered early the next morning in the mobile headquarters building. Major Galt stood at the forefront, a side-view symbolic map of the stellar system displayed on an electronic projection behind him. He had a remote control device in one hand and was speaking in his usual firm baritone.

"Good day, comrades. You certainly recognize this diagram of the Weisau system." Galt pressed a stud and a series of straight lines converged at a single point near the top of the projection, high above the system's ecliptic plane. "This is the location of the JumpShip recharge station at Weisau Zenith, the only operational recharge station in-system. Of course, the jump point itself is nothing more than a set of coordinates in open space."

He pressed the control again, and a small speck lit up in the heart of the system's dense belt region. "This is a large planetoid, where navigational and communications equipment are located. The Draconians refer to it as Jump-Station Kusari." Another press of a button, and the entire display rotated, changed orientation, and assumed a top-view perspective. A somewhat larger dot identified as Weisau traced

an orbit around its primary, the path visibly egg-shaped even on this scale.

Galt continued. "Due to the peculiar eccentricity of the Weisau orbit and the intensely powerful planetary magnetic field surrounding it, JumpShips cannot obtain sufficiently accurate navigational data to reach the jump point without course corrections. Jump-Station Kusari, orbiting at greater distance but following a less eccentric track, transmits this data. Anyone who controls this planetoid controls outgoing JumpShip travel from this system."

"So?" Crazy Jack interrupted. "House Kurita already controls this system."

"I know that, Jack, and I'm getting to my point." Galt bridled. "Since we are stating the obvious, let's not forget that this has been a pretty quiet sector, relatively speaking. The fighting had been concentrated elsewhere, much of it near Dieron and Galtor. It is now believed that a Davion JumpShip containing at least one battalion of 'Mechs is on its way here. According to sketchy intelligence reports, the ship will enter this system within a week's time. It may attempt to drop some or all of its 'Mechs on Kusari, and seize control of the station. After this happens, of course, the Federated Suns can use Weisau as a fleet staging area for further attacks against the Draconis Combine."

"That shouldn't be too hard to defend," Captain Jacobs put in calmly.

"Perhaps," Galt replied. "The only problem is that we don't know for certain if Kusari is the intended target. Certain resource centers on Weisau are equally valuable if measured against different criteria. The Grenadiers will have to defend both."

That causal remark brought the room to utter silence. A single battalion of dispersed BattleMechs is rarely force enough to defend an entire stellar system adequately. Galt flashed another projection on the wall, a picture of a world.

“Kusari is a small planet as much as it is a large planetoid. It possesses a thin atmosphere and extensive frozen deposits near the poles, mostly a mixture of water ice and a slushy compound organically similar to liquified soil. No one seems quite sure what the stuff is, and frankly, I don't care. Our job is to defend it.”

“The jump station itself consists of a series of single story structures and the ground transceiver, an elliptical bowl-shaped antenna about thirty meters across, with two signal collectors in the foci. The Kusari garrison must play a waiting game: either it will have to defend the station against a 'Mech assault for as long as possible, or it can withdraw after several weeks have passed and no attack proves forthcoming.”

“What about an Air Lance? Will the Jaguars be here in time?” That was Miguel Castillo. The aerospace craft in question was a new experimental design from a small company just entering the field. The Jaguar was supposed to be an effective AeroSpace Fighter as well as a medium range reconnaissance craft. Galt's Grenadiers had offered to field-test four prototypes for the firm, but they had not yet arrived. No one knew where they were or what was holding them up. They would have been very handy to have for this assignment.

“No,” Captain Jacobs said. “Holcomb Manufacturing has not been in touch and we are still awaiting word.”

“This means that the Kusari detachment will have to go in without air support. I'm afraid that you will only know when — or if — the Davion DropShip has arrived when you see enemy 'Mechs coming over the horizon, unless you happen to pick up a pulse on the deep-space doppler.”

“Major?” I asked.

“Yes, Sandy?”

“You said that the information may not be wholly accurate. What if the timing is incorrect and their DropShip beats us there?”

Major Galt didn't say anything for a long moment, as he stared at me. “Then we will have to take it away from them, or blow the station up as a last resort. Either way, interstellar access to this system must not fall to the Federated Suns.” He turned and gazed absently at the opposite wall of the building. “Meanwhile, our other 'Mechs will defend strategic locations throughout Weisau.”

“Who's going?” Janonka demanded.

“You are,” Galt responded flatly. “Captains Lopez and Jacobs and I have temporarily reorganized the Grenadiers into nine separate task troops. You will take the Fire Lance plus Deever to Jump-Station Kusari.”

Janonka muttered a profanity as Deever cackled softly.

“Sir,” Robyn began, “may I ...”

“Request denied, Fielding-Sorrell. Any other questions?”

No one responded. “Then that will be all,” Major Galt concluded. Everyone filed out.

Robyn and I were headed back toward our quarters when

Toki called from behind. “Sandy, uh, when can we begin the unit history?”

“Later, Toki,” I called back, not missing my stride. “When I get back.” *If I get back.*

Five days later, Janonka, Wingu, Konishi, Deever, and I were on the Ti Plains of Kusari, about 20 klicks from the jump-station. Without Robyn near, it already seemed as though five weeks had passed.

The Fire Lance of Galt's Grenadiers, with the addition of Crazy Jack Deever, came over the ridge in loose formation on final approach to the communications and navigational tracking station. Everyone got their first unobstructed view of the shallow basin below.

We weren't alone.

“You guessed right for a change, Sorrell,” Janonka said drily over the radio. “Davion *did* beat us here.”

I did a quick 120-degree scan. There were four Battle-Mechs in my field of view, and all bore the sword and sun insignia: two Valkyries, a Stinger, and a Wasp. One Valkyrie was fewer than a hundred meters away, directly in front of me with its left flank exposed. This may be easy, I thought quickly. But then again...

Janonka was talking to me again. “Sorrell, take Wingu and Deever and break left. I'll take Konishi.”

“Affirmative, Lieutenant,” I responded. Malcolm was on my immediate left, with Jack on his left. “Go to freak three,” I added, then retuned my own 'Mech transceiver to another frequency.

“Malcolm? Jack?”

“You got me,” Jack said, laughing.

“I read you, Sorrell,” Malcolm's refined voice came on seconds later.

“Jack, let's you and me take care of this blip; Malcolm, take out that other Valkyrie at about two-zero-zero meters, mark zero.” They responded by initiating fire against their respective targets.

I fired my autocannon, short-range missiles, and laser at the nearest Davion 'Mech, but missed with the autocannon; just *too* close. Jack hit both legs and the right arm, no mean feat when fighting from the left side. I was more directly behind the 'Mech and hit it twice in the right torso, destroying the rear armor, and completely obliterating that section.

The Valkyrie slowly turned around to face the three of us. Each of us fired on it again, and I hit it this time with missiles and laser both, striking the center torso and right arm. In turn, the Valkyrie fired back at Malcolm, its medium laser hitting the Trebuchet's center torso. This particular 'Mech was at a profound disadvantage having to fight at point blank range without its most effective weapon, the long-range missile rack.

“How is it, Malcolm,?” I asked politely, already knowing.

“No significant effect, Sorrell, of course. But thank you.”

Then came the sound of missiles whistling by and impacting against Deever’s Shadow Hawk.

“I’m hit!” Jack cried out. “Right arm and torso, missile fire. The sky is spinning and everything’s going black, hee hee.”

I grinned in spite of myself. “Will you live?” Jack was beginning to sound like Anatole.

“That’s an affirmative.” “Good, we need all the help we can get, even from crazy people.” By this time, the other ‘Mechs from the Federated Suns were advancing in our direction and each of us had more targets than we knew what to do with.

“Sorrell!” This was Janonka. “I’m pinned, can you provide support?” Her Quickdraw was only 130 meters away, facing off against the Enforcer and taking moderate damage.

“I’m coming, Lieutenant. Jack, Malcolm, hold positions.” I moved out, dashed forward, and circled around the Enforcer to get a clear shot from behind. I didn’t like exposing my rear arc to a Valkyrie, but it was better than leaving the lieutenant outnumbered and in a tactically awkward position. I noticed what she meant; her ‘Mech’s outer armor was badly scarred and had been hit at least once by a large autocannon shell. To further aggravate matters, a platoon of rifle-armed jump infantry was underfoot, conducting repeated close assaults.

I fired again but only hit with my autocannon on the Enforcer’s left arm, not enough of a blow to have any real impact. To my horror, I watched several incoming salvos of missiles and a second autocannon shell strike the Quickdraw, severing the ‘Mech’s left arm completely amid a shower of sparks. Almost everyone was concentrating their fire on her.

But not quite. Seconds later, missiles and laser fire also struck my *Gopher’s* rear, badly damaging the armor on the left and center torso sections, not to mention jarring me heavily. It didn’t look pretty, but I thought it would hold barring further hits.

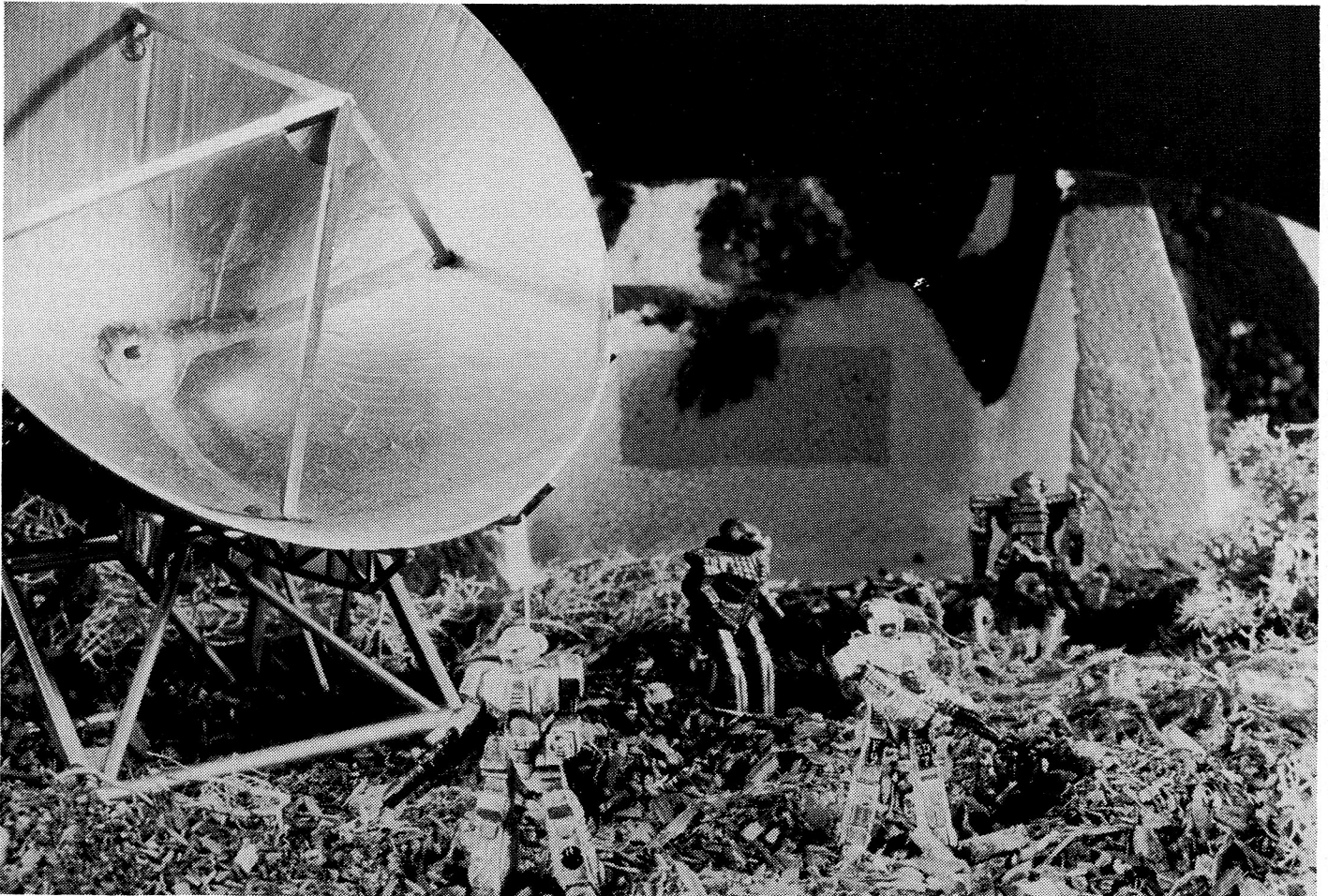

Meanwhile, Janonka continued to slug it out, her Quickdraw looking particularly odd with its left arm resting on the ground directly in front of her position.

I knew her 'Mech could not last more than another half-minute. Desperately, I took careful aim at the Enforcer and jumped in near-perfect "death-from-above" style. My life flashed before my eyes as my 'Mech straddled the Enforcer's right side, hitting its head with my left leg and its right arm with my right. The Enforcer rocked wildly and stumbled forward, but somehow remained on its feet. Gyros whining furiously, I jockeyed to maintain control, but the *Gopher Baroque* fell. I reached out, scrabbling with my right arm to grab the Enforcer's right leg, and missed by only a couple meters. I did my best, but it wasn't enough.

Only the Davion 'Mech had stumbled too far forward. I looked up just in time to see Ludmilla take careful aim and punch with her Quickdraw's remaining fist, hitting the Enforcer squarely in the head and knocking that appendage cleanly off the 'Mech's shoulders. In what seemed like agonizingly slow motion, the BattleMech turned slightly and crumpled to the ground, its pilot killed instantly.

I struggled with the controls and fought the *Gopher* back onto its feet, the left leg suffering from the landing. Out of the corner of my viewscreen I could almost feel a palpable change on the battlefield when the dust cleared. Nearly everyone, Davion and Grenadier alike, took pause to stare at the headless Enforcer. The infantry, previously ignored, was now scattering madly as Kali's 'Mech danced a brief jig and took careless aim in their direction.

I switched to Janonka's private command frequency. "Lieutenant," I said, "I think you should withdraw while you can."

"I'm in command here, Sorrell," the lieutenant growled. "Don't tell me what I should do."

"Ludmilla," I spoke earnestly, "please listen. If you take another major

hit you won't be around to tell *anyone* what to do. I can take over and continue."

Long seconds passed, as the action around us resumed its previously torrid pace, with missiles, volleys, and bursts of laserfire lashing the air.

I heard her sigh heavily. "Very well, Sorrell. Carry on, and regroup at the landing zone."

I sighed myself. "Very good, Lieutenant." She slowly moved off while I provided covering fire. Switching back to the general channel, I called out: "This is Sorrell. I'm assuming command. Status report, everyone?"

"This is Deever. I've been hit in torso and right arm, but I'll live — I promise."

"Wingu reporting. Minor hits on right arm and left torso. Multiple hits on right torso, fairly serious, will try to shield."

"Thank you both." I waited. And waited. "Konishi?"

"What do you want?" She sounded peeved.

"Status report, *please*."

"Oh, very well. This is Kali Konishi. One hit, right leg, armor damage only. Fully functional." I heard her conclude by muttering softly: "Now will you quit pestering me?"

"Thank you. I have moderate armor damage in left and center rear torso, but am still operational. Let's proceed, Grenadiers."

The melee continued. While a Locust pilot and I jockeyed for position, I suddenly heard Deever exclaim: "Good shot, Malcolm!"

As busy as I was with my own battle, I had to ask. "What happened?"

"Malcolm got a rear-end angle on a Stinger and shot its right arm off."

"I'm overheating a little, though," Malcolm added modestly.

I opened up with autocannon against a jump platoon, cutting down half its number, then shifted fire and blasted the rear of the hapless Locust with missiles and laser. No critical hits, but it shouldn't be able to withstand

much more. I think we were winning, but it was terribly difficult to tell.

Then another salvo of missiles came in, striking the *Gopher's* front right torso, closely followed by a laser blast from behind which struck the already-weakened center torso armor, penetrated, and reached the vulnerable engine compartment. In seconds it started to get even warmer in the cockpit and I could smell a trace of smoke; I prayed everything would hold together. The half-decimated jump infantry platoon continued to pepper my 'Mech with machine gun fire which thrilled me not at all. Nevertheless, I was grateful they didn't have missiles, because at the moment I had little else to be grateful about.

The Locust and Wasp on my immediate flanks pivoted to get a better angle on my *Gopher*, so I decided it was another good time to jump, and possibly my last opportunity. "Hold together," I whispered to the leg actuators and jumped, landing almost a hundred meters away and repositioning myself in the Locust's rear arc exactly as intended. I just got a glimpse of a large missile salvo coming from Wingu and striking the Wasp, demolishing the right arm and torso sections. Crazy Jack finished up with more missiles and another burst of laser fire, apparently crippling the gyro. The 'Mech spun around almost 360 degrees, then fell over with a distinct crunch. Twenty seconds later, the four remaining BattleMechs from the Federated Suns were leaving the area at best speed, their surviving lance commander seemingly disillusioned with the outcome.

"Should we go after them?" Jack inquired, chuckling rudely.

I considered the question as I let the *Gopher* idle and wiped a rivulet of sweat from my brow. Several prominent bruises were already forming from the battering; I'd likely be sore for days. Janonka's Quickdraw was seriously damaged, my own engine had suffered a critical hit, and the other 'Mechs of this

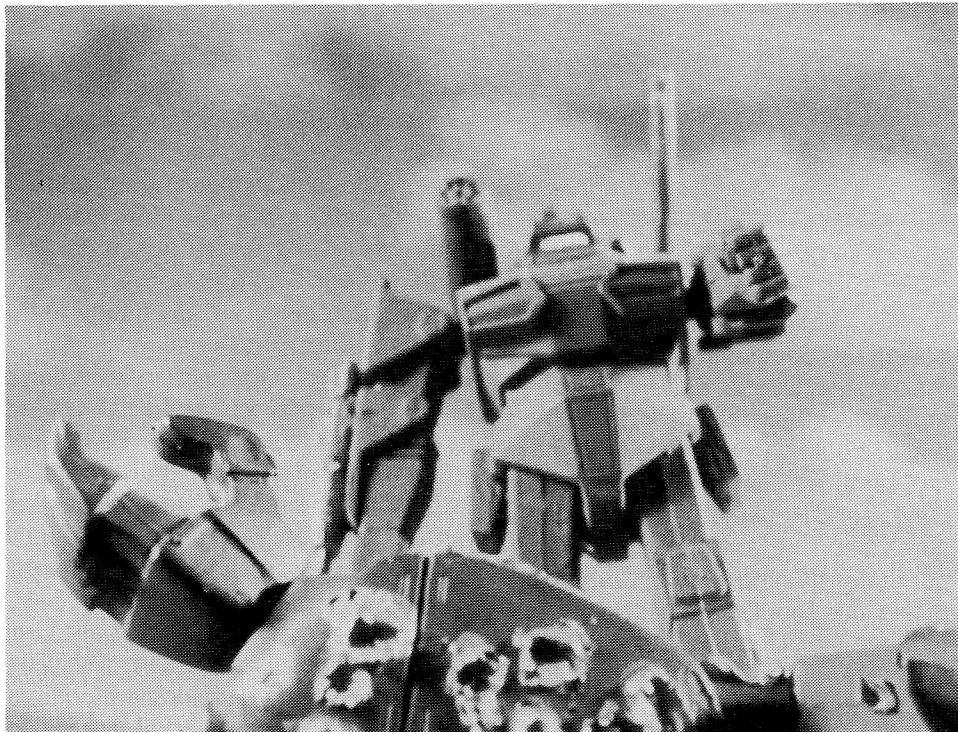

little task force were only in slightly better condition.

"No, Jack," I said finally. "We'll let them get away this time — they won't be coming back. I think we've taught them enough of a lesson. Let's go home." As we headed back in the direction from which we came, I had occasion to pass by the Enforcer where I paused for a minute. It could just as easily have been Ludmilla's Quickdraw or my own Shadow Hawk, but it wasn't. Not this time. I looked at the chronometer on the control panel: less than three minutes had elapsed since I first set eyes on Jump-Station Kusari. Things happen very quickly in battle.

Suddenly I remembered something that I had to go back and get. When I finally rejoined the other 'Mechs on their way to the pickup point, Malcolm gently asked me where I had gone. "Just a little errand," I said vaguely, but then he noticed and nodded. In the *Gopher's* left hand I held the left arm of Janonka's 'Mech.

After another four-day DropShip rides back to Weisau and a ten-hour de-

briefing by Captain Jacobs, I was pletely exhausted, mentally and physically. Major Galt generally was the better officer, but Jacobs' debriefings were longer and even more thorough. By the time I was finished, the only person I wanted to see was Robyn.

I walked from the headquarters building in the direction of my quarters when Miguel Castillo in standard cockpit garb passed by, running at a trot.

"Where are you going in such a hurry?" I asked, waving.

Miguel stopped. "Regular picket rotation," he said, grinning widely despite the gap between his front teeth. "I'm going out with Bester and Dash from the Recon Lance. Normal patrol."

I nodded. "Hey, wait a minute? Where's Robyn? Is she going..."

"Relax," he said. "Robyn and I traded slots. She's waiting for you in your quarters."

Some of my exhaustion melted away. "Oh. Thanks, old friend."

"Anytime," he winked, then took off.

When I got to my quarters Robyn met me at the door, a short, bright, perky, buxom package. She wasn't looking perky right now. "Someone has been waiting for you," she said softly. I could tell from her expression that she meant someone besides herself.

I groaned. "Not Toki, I hope. Listen, I really don't want..."

"Ssh. No, not that nice historian. He is fascinating to talk with, though."

"Well, who is it?" I grumbled.

Ludmilla Janonka stepped through the entrance. She looked uncharacteristically subdued. Now what did I do?

"I'll leave you two alone for a minute," Robyn said, excusing herself and going inside only to close the door.

I looked at my boot. "Yes, Lieutenant Janonka?" I looked up momentarily, only to see that she was looking down at her boot.

"Sorrell — Sandusky..."

I stared, now definitely puzzled.

"Back on Kusari, you did something to me." Whoops, I called her by her first name and practically ordered her out of battle. She must have been perturbed by my audacity.

"L-look, I'm really sorry if I spoke disrespectfully —" I stammered, suddenly nervous.

"No, no, it's not that at all." From the tone of her voice, I couldn't tell if she was angry or apologetic, but she continued. "It's about that bonehead attack you made, jumping on that Davion heavy while other enemy 'Mechs were behind you. It was a really stupid thing for you to do and I just wanted to — to thank you for saving my life by doing it." She looked sheepish, and I think she might have blushed but I never could prove it. Then her face slowly regained its natural scowl, and she turned around and walked away.

I shook my head slowly, then opened the door and entered where Robyn waited. I collapsed listlessly onto a double-settee and she poured beverages. We were both mid-savor when another knock came at the door.

I sighed. "I'll get it," she said, primly.

This time it was Toki, his cheerful face wedged through the partially-opened door. "Oh, good. You are back, Sandy." I waved weakly. "I have only a few questions I'd like to ask right now."

"Sorry, Mr Hoshiyama-Jones," Robyn said firmly, "but I have a few questions to ask Sandy myself. And mine come first."

"But —"

"Please come back in, oh, say a week."

Then Robyn cocked her head at me as she closed the door very slowly on a bewildered Draconis historian.

I stood up and gestured to her to wait.

"No, Toki," I called out, biting my lower lip and grinning, "I think you'd better make it two." Then Robyn closed the door.

Neither of us saw Toki scribble a few more lines on another card and walk off, muttering quietly to himself.

Technical Readout

BTE-3B Beatie Hovertank

We received an evaluation of this new vehicle just before the outbreak of hostilities which became the Fourth Succession War. The report was replaced in our pages by early-breaking war news. During the war, the Beatie has proved itself on several occasions, not all of which have been removed from security silence. We now present that earlier report in plain type, with later additions in italics. Security remains tight on the Beatie, especially on the estimated 30-odd vehicles in existence with the Banzai sensor gear.

Overview 3027

The Beatie was designed with a number of criteria in mind. Its function entailed the varied and diverse roles of armed fighting vehicles in the Battle-Mech environment specializing in reconnaissance and screening duties. Its high speed and heavy armor ensure that it can stand up to most punishment until support can arrive, or until the Beatie can safely withdraw.

The BTE-3B has passed all of its field testing and is now being assigned to front line Armor units within the Armed Forces of the Federated Suns. Security at the Beatie's production facilities on New Avalon and three other planets within the Davion borders is extremely tight, so production totals are unavailable. A source within the Federated Suns Military Procurement Office speculated that as many as 1000 Beatie Hovertanks could be produced within the next ten years. Word has also been received that an initial shipment of 50 Beaties were delivered to officials of the armed forces of the Lyran Commonwealth recently, as part of the military trade and exchange agreement between House Davion and House Steiner.

Only limited testing under actual battlefield conditions has been carried out on the Beatie design, initial appraisal of the vehicle seems to show that it should be a welcome addition to the armored forces of both House Davion and House Steiner. With pressures along the borders of the Successor States heating up to a great degree of late, this should come as good news to those individuals inhabiting Davion or Steiner space.

Capabilities

The BTE-3B Beatie Hovertank was designed for the specific mission of intelligence gathering and the screening of larger forces from the scouting missions of an enemy. Because of this, the design has sacrificed some armament features for the double advantage of speed and protection. It is not meant for use as a main battle tank or other assault function, although military necessity may force its use in these roles.

The Beatie's VOX 265 fusion engine has been newly designed from old Star League circuit specifications and data. It is the first original design in the field of fusion engineering that the New Avalon Institute of Science has attempted since its inception. The Beatie is the VOX 265's first operational testing and so far reports have been positive on its power output and dependability. Shielding and the lift machinery for the Beatie are of standard design, as are the cockpit layout and the instrumentation for the vehicle's two-man crew.

One of the main advantages in the Beatie design is its ample armor coverage. Triple bonded Duroteck Plasti-

steel covers the entire outer shell of the vehicle including the lift skirts. Tests to Destruction on the Cameron Proving Grounds of New Avalon Defense Industries have shown that the Beatie can withstand as much punishment as many of the older well known tracked armored vehicles of far greater tonnage.

The other great advantage to the Beatie design is her speed. With a cruising speed of over one hundred kilometers per hour and a flank speed of greater than 150, the Beatie can surely outrun anything that she cannot outfight. This advantage will act as well as another patch of armor on her hull; she can put distance between herself and any possible opponent.

The armament of the Beaties has led to more disagreement within the Davion military development community than any other part of the design. Everyone knows that any war machine design is a trade-off in very specific categories to make that vehicle as well rounded as possible, and at the same time to allow it to perform its designed mission portfolio up to specification. The Beatie design was able to accomplish this, but at the sacrifice of much heavy armament seen on other vehicles of similar tonnage.

The Beatie's main armament is in the form of a Diverse Optics Type 20 Medium Laser housed in a port sponson-mounted turret on the fore part of the hull. On the other quadrants of the hull, mounted in free-rotating turrets of their own, are two NADI-36 Short Range Missile Six-Packs. The NADI-36 is another new weapons system designed by New Avalon Defense Industries, mounted in two triple launchers for each SRM-6. The original design called for independent tracking and targeting for each of the triple launchers so that up to four targets could be engaged at one time by the short range missile mounts alone. The sensor gear development has fallen extensively behind schedule so standard Chichester ASR-26 units with no independ-

ent tracking ability have had to be installed in their place. Most of the designers feel that this should not effect the Beatie's usefulness in any way as most of the time the vehicle will withdraw if confronted with four or more targets.

Battle History

To date, there has been only one recorded engagement in which the Beatie Class Hovertank has taken part. During the on-going border clashes between House Davion and House Kurita forces in what was termed Operation Galahad last year (3026, the first "peacetime wargame" Operation Galahad), elements of the Second Sword of Light Regiment raided the garrison planet of Breed in reprisal for a similar attack by Davion forces on the Kurita border planet called Sheat V. Breed was one of the testing sites for the Beatie; a company of twelve vehicles along with spare prototypes had been stationed there some months before the attack.

The Kurita forces had dropped in battalion strength; they seemed to have orders to conduct merely a search and destroy mission on any Davion facility encountered, then to withdraw offplanet. Davion defense forces were at reinforced regimental strength, but were scattered about the planet, leaving the 30-odd 'Mech force of the Draconis Combine superiority on the local level.

Colonel Brent Richardson, commanding the 101st Testing and Training company, was ordered to set up a screening line across the intended line of approach of the Kurita 'Mechs toward their next target, a hydrogen fuel refining plant. They achieved first contact with a recon lance of the enemy and began to fall back on waiting Davion 'Mechs near the Kurita objective. The Draconis 'Mechs were unable to bring the Beaties to engagement because of their slower speed, but neither were the Beaties able to offer any appreciable fire at the advancing enemy. Finally, Davion 'Mechs were able to come into support range and the Beaties began to outflank the attacking Kurita force by performing tactics which they had practiced over the last few months to obtain rear shots and then withdraw before they could be brought to battle. After several hours of steady defense by the Davion 'Mech forces and harrassing fire from the company of Beatie tanks, the Kurita commander decided to withdraw back to his waiting DropShips. The Beaties continued to pick at the force as it fell back, but the AFFS had achieved its objective: the raid caused minimal damage and only one Beatie was lost in the fight.

Variants

Since the Beatie design is new, no variants have been approved or projected. However, there has been some discussion about removing three tons of armor for the addition of one LRM-5 rack and its missile load.

Toward the end of the War some thirty-odd Beaties were fitted with new sensor gear developed in cooperation with Doctor Banzai

and the NAIS. During the last days of the War this company served with distinction in the Capellan March theater.

Notable Vehicles and Crews

*Brigadier Brent Richardson
Promoted and transfered from the 101st Testing and Training Company, Brigadier Richardson was placed in charge of the Beatie Hovertank disbursement program to get all assembly line-completed vehicles to their assigned units in the least possible time. In addition to these duties, he is in command of the New Avalon Guards Armor Cadre which has recently been equipped with Beatie Hover-tanks. His personal Beatie, 'Lil Beastie II', takes him to long distance inspection tours and maneuvers, freeing an Aerospace Transport Carrier for the front line.*

BTE-3B Beatie HoverTank

Mass: 50 tons
Movement Type: Hover
Power Plant: VOX 265
Cruising Speed: 109.5 kph
Flank Speed: 154.1 kph
Armor: Three Ply Durotech Plastisteel
Armament:

One Diverse Optics Type 20 Medium Laser
 Two NADI-36 Short Range Missile Six-Packs

Manufacturer: New Avalon Defense Industries
Communication System: Garret T19B
Targeting and Tracking System: Chichester ASR-26

Type: BTE-3B Beatie Hovertank **Tons**
Movement Type: Hover
Tonnage: 50 tons 50

Cruise Speed: 10
Flank Speed: 15

Engine Rating: 265 14

Type: Fusion

Control: 2.5

Lift Equipment: 5

Internal Structure: 5

Shielding: 7

Turrets: 1

Armor: 72 4.5

Location **Points**

Front: 30

Lt/Rt Side: 19/19

Rear: 12

Turret: 24

Weapons and Ammo:

Type	Facing	Tons
Medium Laser	Turret	1
SRM 6	Turret	3
SRM 6	Turret	3
Ammo (15)	Body	2

BTE-3B BEATIE HOVERTANK

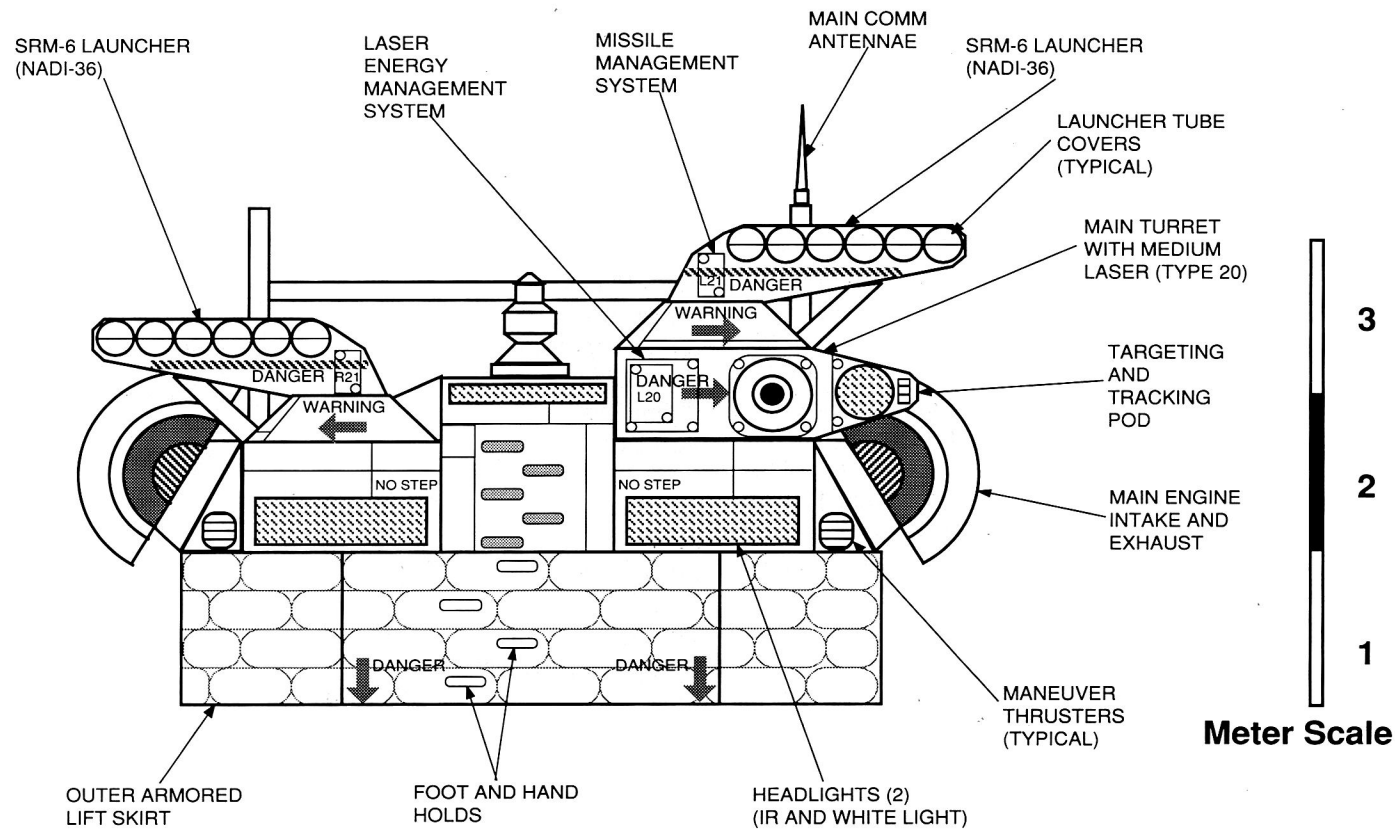
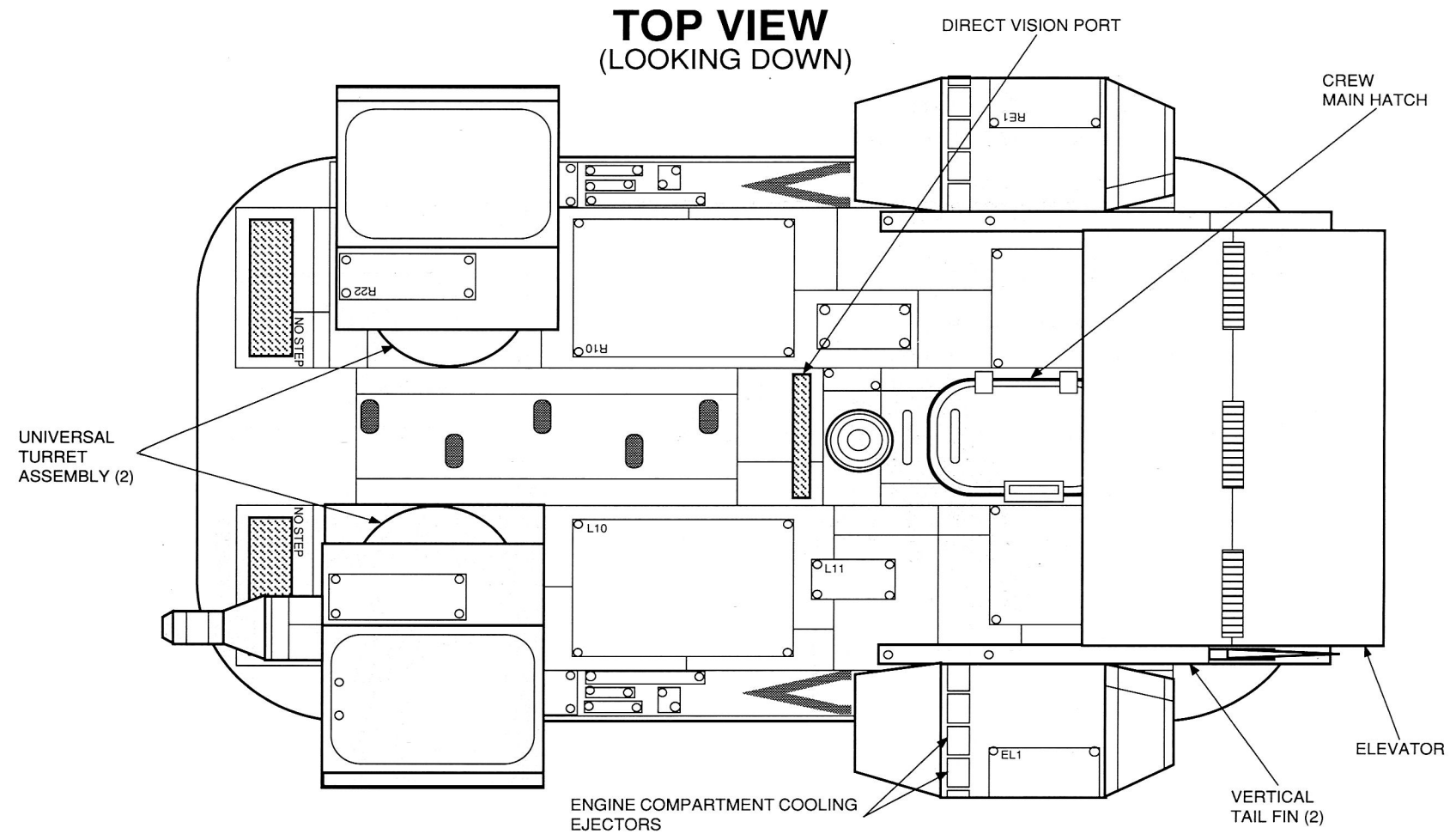
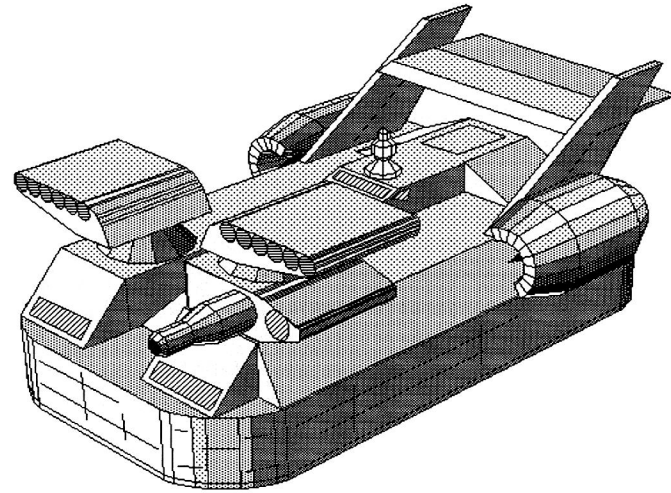
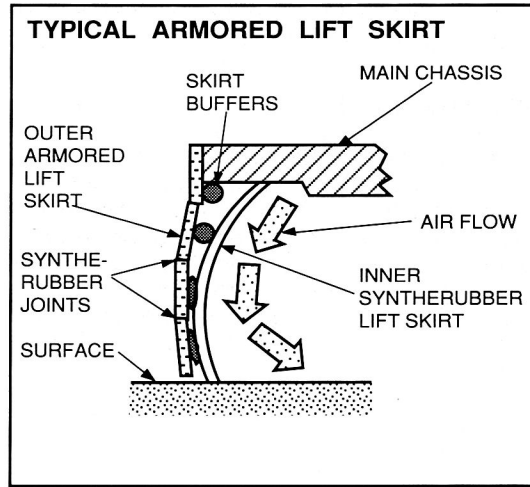

FRONT VIEW (LOOKING AFT)



Meter Scale

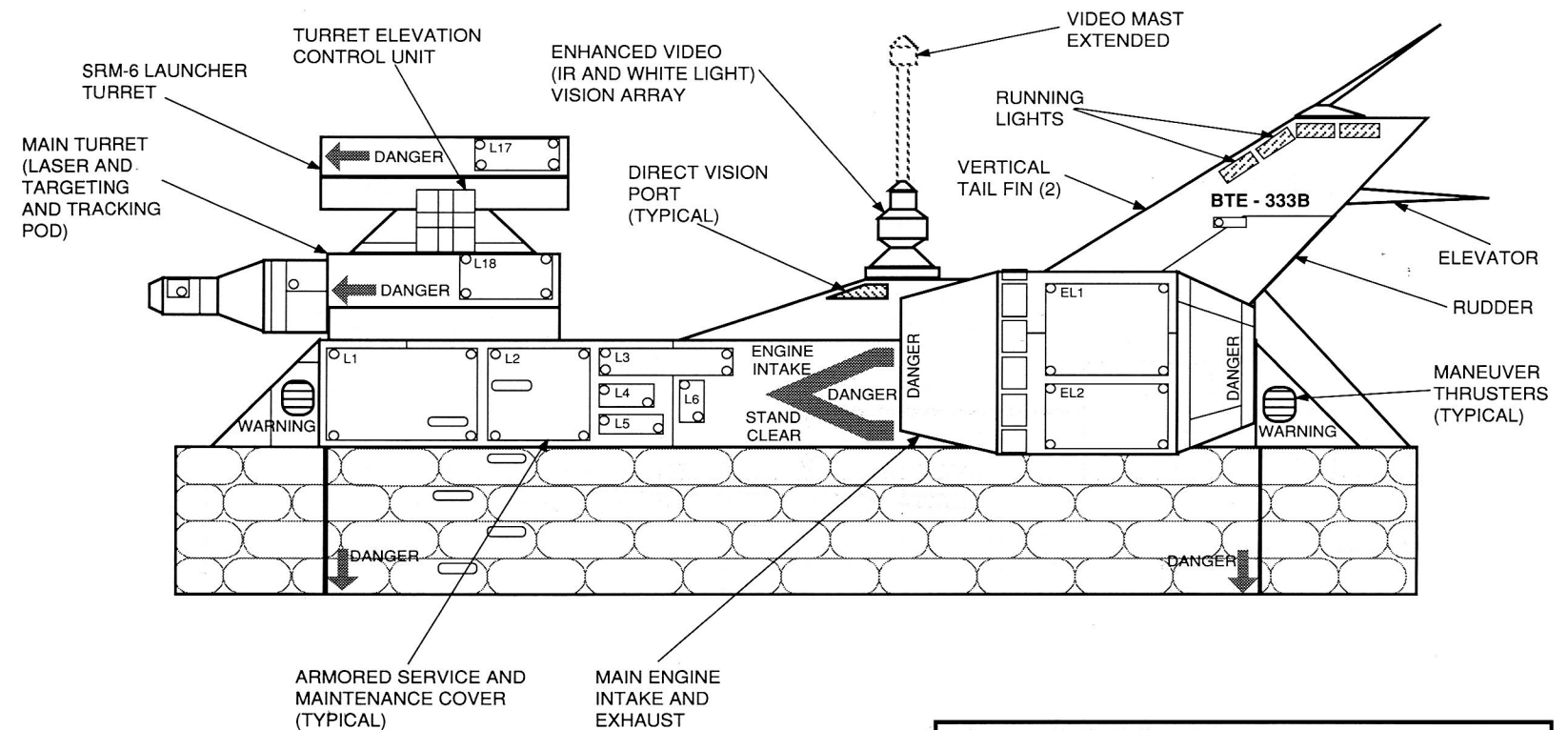

LEFT SIDE (RIGHT SIDE TYPICAL)

FIRE CONTROL DIAGRAM

GENERAL BATTLE MECH OPERATION - 394

CREW INTERFACE WITH WEAPON CONTROL SYSTEMS

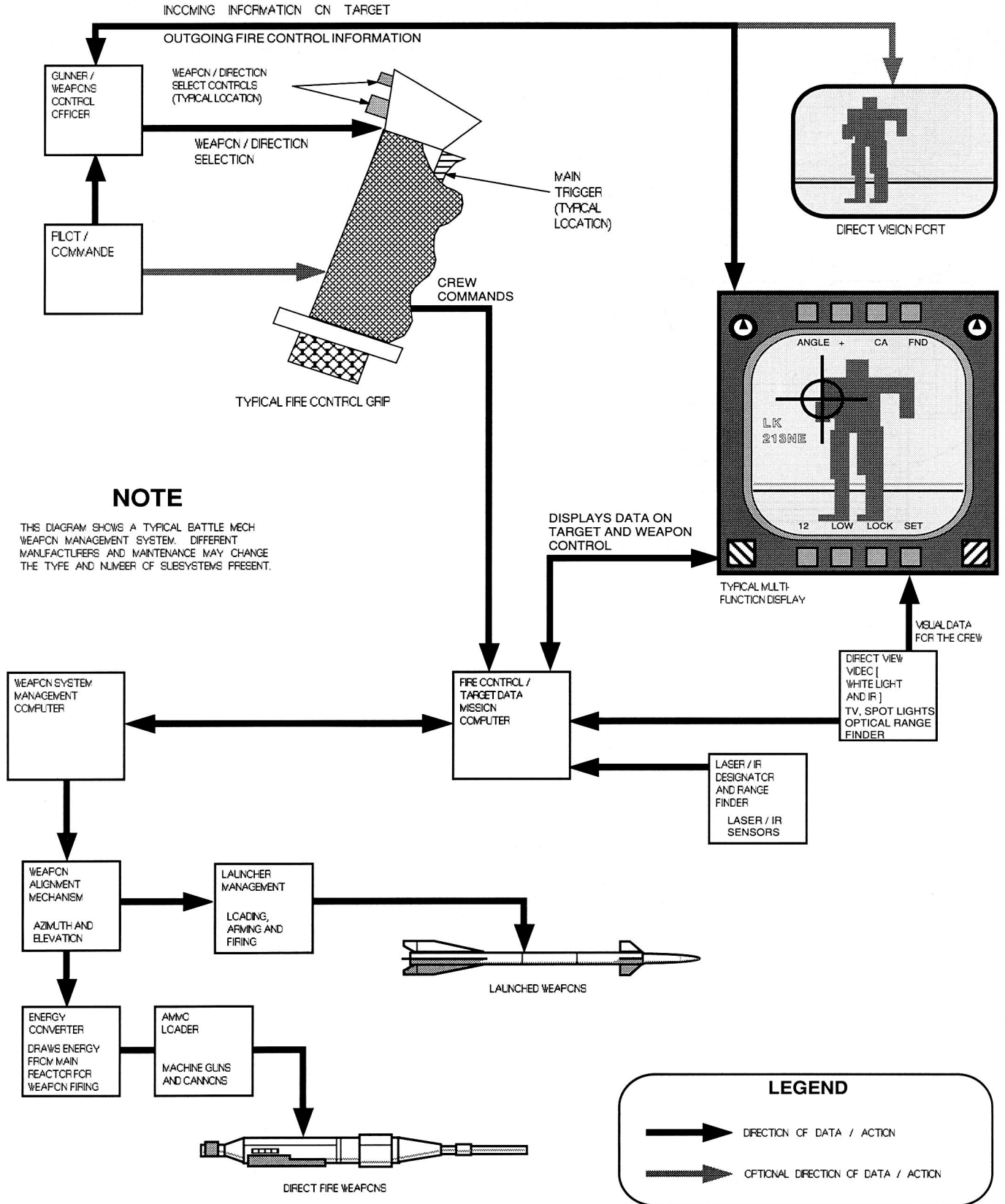

INCOMING!

In the next,
action-packed issue
of **BattleTechnology**...

- Raselhague Rebels
—The Ronin Reaction
will Skye follow suit?
- Tor Miraborg
—an exclusive interview
with Rasalhague's Iron Jarl
- Assassination, part two
—Which of the Thirty First Century's
prominent figures is next?
Why is Mikial Dragnos
a hunted man?
- Not Always a Great Notion
— the latest from the Cobalt Coil
another secret of the PPC
- Power Struggle in the Periphery
— attempts on the life
of the Magistrate of Canopus
- Plus other feature articles; regular
columns; battle simulations; news
from the Inner Sphere...

**AND MUCH, MUCH MORE!
DON'T MISS IT!**

Missing MechWarrior — Robert A
Gross Jr please contact our Terran office —
you've come into money!

Survival in a Hard School

the recent history of House Marik
from an informal source

It has been a long evening. What was supposed to be a family dinner turned as usual into a council meeting, except that he had fewer supporters in the family. They were all saying goodnight to Bronwen now: The confident nephew who never seems to age. The dashing son who never seems to doubt himself. The youngest son, the quiet one who watches. Duncan. Duggan. Thomas. Duncan had brought his bodyguards again. The palace cooks made chicken paprikash, after all these years, still a favorite from his childhood. They'd served some crisp local wine; it should have been perfect. Except for the company.

She moves behind him, not so quietly as to alarm his battle reflexes. She reaches out, begins to rub his neck. Her hands know just where to find the tension. As they probe and knead the knotted muscles, Janos Marik gives a great sigh. The recording disk clicks on as he begins to speak.

"Where does it hurt, Bronwen? My body is reflecting the questions in my mind. I wish you could sooth the pains and tangles there as easily as you — uug — yes, right there — take care of my aching back.

How will history regard the Fourth Succession War? How will the actions I've taken during this war be remembered? Will they say I was indecisive? Cowardly? Stupid? A wise statesman who kept his people as safe from a stupid war as could be arranged? I've giving up hoping that anyone will ever understand me, or understand what it's like to be The Marik. Lately I've come to understand that only historians even try to understand — and they all have axes to grind. Oh, my children, the Parliament, they try to understand me well enough to manipulate me. But to care for the truth, for an honest assessment of what I tried for, what I want to accomplish? Never.

You see, I do know my failings. When I first took the Captain Generalcy, I had such high ideals. I was going to unify House Marik, to realize our potential for peacetime expansion and growth. We're a region of merchants, but that's not a weakness, it's a strength. I gave my tutors more than one good argument for the theory that new developments in history were almost entirely due to the intelligence, self-interest, and enlightened culture of the merchant class. We were war torn then, and shattered. Corruption was everywhere. For two years I traveled constantly, seeing for myself every corner of the Free Worlds, talking to people, reading local newspapers, available to anyone who had a cause to plead or an idea to share. In those days they called my council of advisors the "Council of Friends", did you know that? The I planned the Great Celebration, a year of Festivities to usher in the Fourth Millenium. My wife died; it saddened us all, but we decided to make the celebration her memorial. I don't mind telling you that I do better with a good woman in my life. No need to be jealous, my dear, you're very good at being a woman!

The Great Celebration...Catty Humphreys opposed it, of course. So did the Exituri. The spirit that rose, Bronwen! I told our people that I would

not pursue military objectives until I knew I had their support. They united behind me. I stamped out corruption in our military. I married a new wife. The Federats attacked us in the midst of our celebration; we swatted them away like ants. We took on the Lyrans and Max Liao. In some ways, I wish I had died then.

Max Liao. They say he's quite insane now. I hope he suffers. Always subverting us, sowing dissent. Getting Catty stirred up. Trying to get Christopher Halas to fight me — not much luck there! My brother, my son. He got to both of them. I hope he suffers long.

Takashi Kurita stuffed him down my throat. For how many generations has House Marik wanted an alliance with Kurita? And to have the actual meeting taking place, the diplomats working on terms...and he says that without Liao it's not going to happen? The Concord of Kapteyn! If Liao and Kurita were going to ally, and Hanse Davion was already allied to our old enemy the Lyrans, what could I do against either block? I had to ally with him. The three of us had a chance at smashing them. After all, Takashi might have been able to control that twisting weasel Liao.

But when the war started all Takashi would think about was Wolf's Dragoons! He'd insisted on combined operations, and he'd insisted on control staying with him. Combined

operations! Even Max and I cooperated better than the DCMF and our military! So I said, "Let's relax and enjoy the sights — we can pick up the pieces later!" I said that in a 'Private Family Gathering' — it's the one remark I can be sure will live after me! It's been misquoted across the Inner Sphere and back again. I think, in the entire year and a half of war, the combined staff met exactly twice! Takashi and his continual demands that I *DO SOMETHING!* I took a few pokes at the Lyrans on general principles, and tried to keep that Humphreys woman from starting a war with Liao. I've dreamed of locking Takashi in a room with Catty Humphreys and seeing who comes out alive! Maybe if I were lucky, neither of them would!

Ceding those planets to Ridzik. That was an error. I kept him negotiating all those months while Sortek pushed for action. There were our diplomats hammering out the final terms of a treaty — the next day they were all interned as enemy aliens! Once Liao, Liao always! And then I gave that territory back to the Lyrans. If you don't think that hurts! Takashi kept telling me he had a plan! Our intelligence people were convinced the Steiners were massing for an invasion; Sortek was readying a strike on the Liao front! I had to consolidate. I had to sacrifice. All the planets between Callison and Wyatt! Launam, Milton, Phecda, Timbiqui. You'll find those names written on my heart when I die!

It was only one week, *one week later*, that I heard of Ridzik's assassination! If Max had indicated that he was taking any action, any action at all! If Takashi had offered — or had responded to my offers — any joint action on the Lyrans Front...Alliance! The Concord of Kapteyn is waste paper!

Still... Max's realm is gutted. Takashi is weakened — though nobody denies that a weakened Draconis Combine is still a dangerous thing to fool with. And our economy is whole; we're already gaining trade advantages over the Lyrans. They can't deliver; they've spent it all getting the daughter of the House a husband. Our forces are almost untouched. I was tricked into losing thirteen systems and much of our access to Kurita. But if the people will rally behind me, we have a chance to make some real gains while the Federation and the Commonwealth are still reeling from the war. You don't just win on the battlefield, you know!

Thank you, Bronwen. It always does me good to talk things out. I feel better already. Give me your arm into the next room and we'll work on the measures for the spring parliamentary session.

By the way, my dear, it's time to give up your fling with my hearty son Duggan. He'll never succeed me. And don't look at Duncan, my sister's son! You might as well enjoy your last years with the Old Man. Because the new one won't be as frivolous."

There is a sound of two voices laughing; one sounds a bit uneasy. Footsteps move away. The tape clicks off..

BattleTechnology acknowledges that the use of sophisticated bugging equipment is a great invasion of privacy. In theory this widespread practice should be condemned.

Since we do not live in an ideal universe, and since someone was going to print what would have been the private thoughts of a man to his diary — no, let's be honest — since it was a unique opportunity to see into the mind of an enigmatic and private man, we are printing the contents of this anonymous but unmistakably authentic disk. The individual who supplied us with the diary entry swears that she wishes only to have the Captain General more fairly understood by the general public.

The Theory and Practice of Assassination

by Mikial Dragnos, Marik Scholar for 3029

Assassination; the word strikes fear into the heart of every public figure. It is the specter that walks always behind men and women of power. No one who must be in the public eye can guard at all times; each is vulnerable to the knife, the bullet, the bomb...or the poisoned cup of wine.

The term *assassin* dates back to the time of on Hassan-il-Sabbah who lived in late 11th or early 12 century Terra. He created a religious order of killers; the word assassin is considered by some authorities to be a variant on this man's name. The word assassination as it is used here is defined as a killing, done to make either a political or an economic statement with the hopes that the successor shall be an improvement on the previous official. Because of the enormous number of assassinations throughout the histories of the various houses, this paper will only deal with the greatest and most well known of assassinations.

We shall look at five assassinations, two from House Marik and two from other Successor Houses, and one failed attempt. The first four will be compared by techniques, effectiveness, and aftereffects. The final one will deal with the attempted assassination of Elizabeth Steiner and its effect on Marik, Steiner, and Kurita relations. Lastly, I'll give a potential outlook on future attempts, where they are likely and by what methods.

The first two assassinations to be looked at will be the assassination of Geraldine Marik in 2364, and the Steiner Operation Praying Mantis of 2848-50. In the mid-2300s, House Marik had recently begun employing official food tasters to prevent food poisoning; a dwarf was used because any food poisoning would take effect more quickly and be noticed sooner in an individual with a smaller body mass than in a more normal-sized person. In 2363 one Mohammed Kimborough, the food taster, became violently ill, and he was found to have arsenic in his system. Tests indicated that the Captain-General was being slowly poisoned by arsenic as well. Kimborough was treated as a hero. After a year of recuperation, he came back to work and promptly put large amounts of ground glass in Geraldine Marik's food. (He was so trusted that nobody looked at the food after he tasted it.) The Captain-General died three weeks later; Kimborough escaped and was never found. Operation Praying Mantis was similar to this. A female Lyran Intelligence Corps agent

was carefully placed in one of the Courtesan schools in the Draconis Combine. (To be specific, a school in the Rasalhague district.) She was able to catch the eye of Yoguchi Kurita, and he had her brought to the palace on Luthien. On a dark night after he fell asleep, she slit Yoguchi's throat. She placed a patch from the Steiner 4th Royal Guards on his now lifeless body, then poisoned herself to ensure that no information would be taken from her.

The techniques used by these two assassins are of similar intent. The dwarf had insured his credibility to the Marik by making it appear that someone else was trying to kill her. The assassin known only as Snowfire played on the Coordinator's known liking for the fairer sex, then struck quickly as a snake. Each spent long periods of time and gave careful attention to creating or making a credible background, developing a relationship with the victim which made the victim trusting and therefore vulnerable. Each assassin played on the peculiar vulnerability of the victim, and succeeded in achieving the victim's death. Unfortunately, the effectiveness of this particular technique gave the *governments* concerned a shock, and insured that these particular techniques would not be used successfully again. Of course the aftermath in each case was something to take note of. In the Free Worlds League, the new Captain-General was kept

The assassin cult: originally created as an extremist Muslim sect led by Hassan-il-Sabbah. He showed the cult members one at a time that which would be considered heaven by the cultists. This was done by the correct combination of drugs, staging of an event, and appropriate stimuli. He could give a vision of Hell with the same techniques. For example, he would have a man's head cut off for failing the cult, then the cultists would "see" the man's head "speak from hell". Each assassin was dedicated; he "knew" where he would go if he failed the cult, and what reward would be his if he were faithful. Of course the assassin was specially trained. An assassin needed to know several languages, disguises, the ability to take on different roles, and the expert use of the dagger as weapon of choice.

under house arrest and even kept sedated by his uncle for an extremely long time, winning free from his imprisonment under great difficulties. In the Draconis Combine, an attack in force was made as reprisal on the Lyran planet of Hesperus II, the heart of House Steiner's BattleMech production. The attack ultimately failed because of the overextended supply line; the Kurita forces could not continue what amounted to a siege for a long enough period of time. Each of these assassins succeeded by methods of a subtle nature. Each of these assassinations brought a change to the affected house, but were they the changes desired by the assassins?

Methods of assassination are of two types: the first uses subtle and careful means; this seems to have a greater success rate than the second type, which is the use of violence and terror to produce change in one's own or another government. The second type involves either a public killing or the destruction of public buildings with their inhabitants to make a political statement. Let us take a look at two other assassinations of a more violent nature, and their radical effects. These assassinations are those of the Black Prince of House Davion, and the Scourge of Death incident in House Marik.

The Black Prince, James Davion, who was assassinated in 2467 for reasons which can only be guessed at, was a womanizer who felt no guilt and who made shameless use of his rank. He proved to be a capable leader, so it was assumed that his people had decided to overlook certain matters. Someone did take offense, it is certain, because they shot and killed him together with his aides, severely wounding several others and crippling Ellen Davion. The assassin was never found.

This particular assassination turned out to be one of the most effective ever in causing a beneficial change in government. Ellen Davion, also known as the Lady in the Wheelchair, turned her brother's death into a great personal victory for all of womankind. House Davion was going through a phase of antifeminism, particularly in the military forces. Many critics thought her unsuited for office because of her sex and her crippled state. But she ruled for the next thirty years in what The House Davion annals call The Golden Age. This is one of the few times that an assassin's bullet may have succeeded in fulfilling its ultimate goal.

The Scourge of Death Incident in 2677 was what a terrorist group could call the Penultimate (next to ultimate) Assassination, the near-total annihilation of the ruling family after a decade of violence. The assassin had spent several days observing the house to find out the best places to set the explosives to ensure that as many as possible, most if not all of the Marik Household would die. Out of forty-one people in the house at the time of the explosion only two survived: Gerald Marik, and a 3rd Marik militia commander. Gerald Marik required much bionic reconstruction just to survive.

This bombing was highly effective in terms of numbers, but its aftermath was a shock to everyone, most probably even to the assassin's faction. When Gerald Marik took office two very important things happened. First, he ordered the utter destruction of the Scourge of Death terrorists; he succeeded in getting rid of so many of them that they would never strike again, and nobody would wish to follow their example if it meant suffering their fate. The second item of importance gets us into the controversy over bionics; the question was raised of whether bionics have a dehumanizing effect on the people who have them implanted. To attribute Captain-General Gerald's actions to dehumanization is absurd. The loss of the entirety of his family was sufficient to explain the actions that he took to ensure the safety of his wife and children and the safety of the Realm against the attacks of those who would have loved to see utter anarchy rule the Free Worlds League.

Let us now compare the second pair of assassinations to determine how effective they were. Each of the assassinations ended up leaving many people hurt and/or killed. Each also made some sort of personal statement for the person or group doing the assassination. Each of the attempts was a catalyst for great events which rocked the very foundations on which the House concerned was built. Let's compare each point separately. First: the amount of injured and dead from each one. The Scourge of Death, though it had a higher body count, tried to make sure that few "Innocents" were hurt; unlike the Black Prince incident where too many "Innocents" were killed.

Second: the statement being made by the assassins. When the Black Prince was killed, the killer was probably rebelling against the prince's abuses of power in dealing with the opposite sex. It may have been a jealous boyfriend or an irate father; it could have been an angered husband. This is the only logical reason for his death because in all other respects, he was a good leader. On the other side of the coin is the Scourge of Death and their message. Theirs was one which they had been stating for the previous ten years. *Those who are Star League members or supporters must die, for the Star League is an evil, self-destructive monolith which must fall.*

Finally, the aftereffects were incredibly different although the situations after the assassinations were very similar. Both of the Successor Lords were wounded during the assassination and had need for some sort of mechanical contrivance to aid them, be it a wheelchair or bionics. The course of action was different from this point. The new Prince Ellen Davion was an able, efficient, and beloved ruler; she was able to all but eliminate the woman's stereotyped image in the Federated Suns. That was all that she managed to salvage from the ruins. On the other hand, Captain-General Gerald Marik took up the reins of leadership and began a crusade to show that



Snowfire: the information on her is sketchy; for example, she is known to history only by her courtesan name; but from the archives it may be possible to reconstruct more of her background. She was about 25 years old, very beautiful, highly intelligent, and probably dexterous to a fault. This can be seen by her rise in the Ukiyo, from Rasalhague as a lowly Geisha girl to the Royal household. She was loyal to the Lyran Commonwealth, and cared deeply for the lover whom she knew she would never see again. She was expert in the use of a knife; a single blow killed the Coordinator.

terrorism would not survive under his rule of the Free Worlds League. He eliminated what amounted to a great thorn in the Star League's side

Now let us take a look at the attempted assassination of Archon Elizabeth Steiner in 2867 which was ordered by Phillipa Marik; how the Archon's use and choice of guards enabled her to survive, and the long range effects of that survival.

In 2566 a major earthquake hit Tharkad City. The then-Archon Tracial Steiner ordered the old government house destroyed, and a new one built. At that time, an architect who had a grievance against the government sold the plans to Marik agents.

So in 2867 when the assassination was ordered, the plans were used to get the Marik assassins as close to the throne room as possible. They were able to reach the throne room itself without any incidents, but there they received a

huge surprise. When the doors opened they found that the Archon had 2 BattleMechs along with her normal personal guard. Her 'Mechs eliminated the assassins in very short order. Of course when the Lyran Intelligence Corps examined the scene, they found the secret passages, and secured them so that assassins could not get away with a stunt like that again.

A reprisal would seem to be the normal reaction to such an attack. But the Lyrans did not strike back in any real form; this failed attempt seemed to lower morale rather than to strengthen it. The incident showed positive proof to the Draconis Combine that the Free Worlds League and the Lyran Commonwealth would never work out their differences, thus opening the way to a potential Kurita-Marik treaty.

Even though the assassination was unsuccessful, we can still look at it and see how we could improve a plan which failed to the point of possible success. An improved plan would have been a variation on Operation Praying Mantis and on the Scourge of Death incident. The patient waiting until Archon Elizabeth was either alone, or with as few of her guards as possible, and no BattleMechs were present; the quick use of a knife, much quieter than a gun. An assassin who could have been patient would most likely have been successful, escaping afterward through the secret passages, leaving the possibility that they would remain unfound, a way to get at another Archon in a future time.

And the actual effects of the attempted assassination to the Marik, Steiner, and Kurita interrelationships? House Steiner was being attacked on two frontiers by the other two Houses. Somehow the attempt on the Archon's life took the heart out of her forces. It is a matter of record that for the next two years the Steiner 'Mechs lost several worlds; each time they regained a world they seemed to lose two more. In the Marik-Kurita relationship, this long campaign allowed the chance for an agreement which eventually came to pass with the Treaty of Kapteyn, after Steiner and Davion allied.

As we have seen, assassinations and attempted assassinations are crucial in Succession House histories. Assassination can be used to make a personal statement, or a political statement. It would be foolish to presume that assassination is a tactic limited to the past. Perhaps another Archon will be approached in a more subtle manner. A private courier who needs to see her alone in her office? A knife made of the new plastics which are not scanner-detectable? Perhaps the hostility between father and son in House Kurita will result in an abrupt change in the Coordinator's position? Perhaps a Marik will eliminate several of the other candidates for the Captain-Generalship after the Marik passes on? I venture to predict that within our lifetimes the Successor Houses will experience an event of this kind; for the House involved, the life of its people will be deeply affected by the ancient legacy of Hassan-il-Sabbah.

**Modified Griffin
Special 'Mech of the
Steiner Personal Guard**

Simulator Stats:

Type: GFN-I RG	Tons
Tonnage: 55 Tons	55
Internal Structure:	5.5
Engine: 275 CoreTek	15.5
Walking MPs: 5	
Running MPs: 8	
Jumping MPs: 0	
Heat Sinks: 17	7
Gyro:	3
Cockpit:	3
Armor Factor: 160 AV	10

Internal

Armor	Structure	Value
Head:	3	9
Center Torso:	18	20 / 9
Rt / Lt Torso:	13	20 / 8
Rt / Lt Arm:	9	15
Rt / Lt Leg:	13	18

Weapons and Ammo:

Item	Location	Critical	Tons
Large Laser:	RA	2	5
Medium Laser:	RA	1	1
Medium Laser:	RT	1	1
Medium Laser:	CT	1	1
Small Laser:	RT	1	.5
Small Laser:	LT	1	.5
Machine Gun:	RT	1	.5
AMMO	RT	1	.5
Machine Gun:	LT	1	.5
AMMO	LT	1	.5

UNLEASH YOUR IMAGINATION...



**DEALER
INQUIRIES
INVITED**



**\$99.95
PER SET
58 PCS.**

Tired of playing your game on the same old board? Move up to the world of 3-D terrain simulation with **BATTLESCAPE™** from GEO-HEX. Based on our award winning and critically acclaimed GEO-HEX™ Terrain Simulation System, **BATTLESCAPE™** is both a flexible terrain display system for miniatures and hex grid gameboard rolled into one.

NO ASSEMBLY IS REQUIRED !!

Covered in your choice of either grass green or desert sand flocking, each **BATTLESCAPE™** set comes completely finished and ready for use. Now you can model streams, rivers, hills, islands, cliffs, etc., from the moment you open the box. And while the unique, patented shapes allow you to create an endless variety of landforms, the overlying 1.5 inch hex size grid allows you to use boardgame rules and movement systems. So leave flat, featureless gameboards behind; ask your local hobby dealer about us or contact us directly at the address below, and enter a realm of adventure with **BATTLESCAPE™**!

**609 NE Schuyler, Unit #1
Portland, OR 97212**

New Address:

**(503) 288-4805
Contact KR**

A COLOR CATALOG OF OUR FULL LINE OF TERRAIN PRODUCTS IS AVAILABLE FOR \$3.00 U.S. VISA AND MASTERCARD HOLDERS CAN CALL, OTHERS SEND CHECK OR MONEY ORDER.

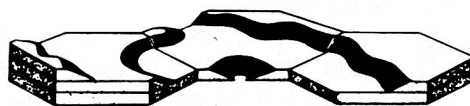

GEO-HEX

IF ORDERING FROM THIS AD PLEASE INCLUDE SHIPPING WITH ORDER. U.S. SHIPPING, 5%; CANADA, 12%; OVERSEAS SURFACE, 15%; AIR 30%. ALL PAYMENTS IN CURRENT U.S. DOLLARS. PRICES SUBJECT TO CHANGE WITHOUT NOTICE.

Callison

Callison, July 25, 3029
MechWarrior Daniel Rolman,
Wasp pilot, Marik Guard
interviewed by Anders Craig,
BattleTechnology Weekly News

BT: I understand that the attack came as a surprise?

Rolman: When you're trying to play a game of King of the Hill, waiting for 'Mechs to come over the edge; yes, infantry is a bit of a surprise.

BT: Where did the encounter take place?

Rolman: A bit south of the spaceport there. It was on top of a hill — actually, more of a cliff. Another surprise — we walked into fire from lasers and SRMs. Those Hsiens know how to equip their troops!

BT: What sort of tactics do you use against infantry?

Rolman: Are you talking physical attack or long range combat? We have the advantage always in long range combat. Take out lots of them where they can't get at us. Of course they have the advantage — or they think they have the advantage — when they get you down, say prone.

BT: Are you saying that a 'Mech is not at a disadvantage when it's caught in a fallen position?

Rolman: No, it's not — if the pilot has been trained in street fighting. Have you ever seen a baby when it throws a tantrum, how it thrashes about? Well, think of all those wonderful infantry guys swarming around your 'Mech for the perfect shot — and you throw a tantrum! Just like a fish out of water. Think of what happens to all the little grunts. Just like the guy in the story who killed seven at one blow. Just mind your 'Mech. You could damage it doing them in.

King of the Hill

Background

The Hsien Hotheads were moving in on the spaceport when elements of the Marik Guard encountered them. The first contact was between a Recon Lance of the Guard and a company of Foot Infantry. Battle was joined immediately.

Game Set Up

Set two boards end to end. The terrain is Rough, spotted with light woods. The North and South edges of the board are small cliffs which are Level 3. If a 'Mech goes off one of these edges it will take two levels of damage as per falling damage in the BattleTech Manual, p 27.

July 24, 3029

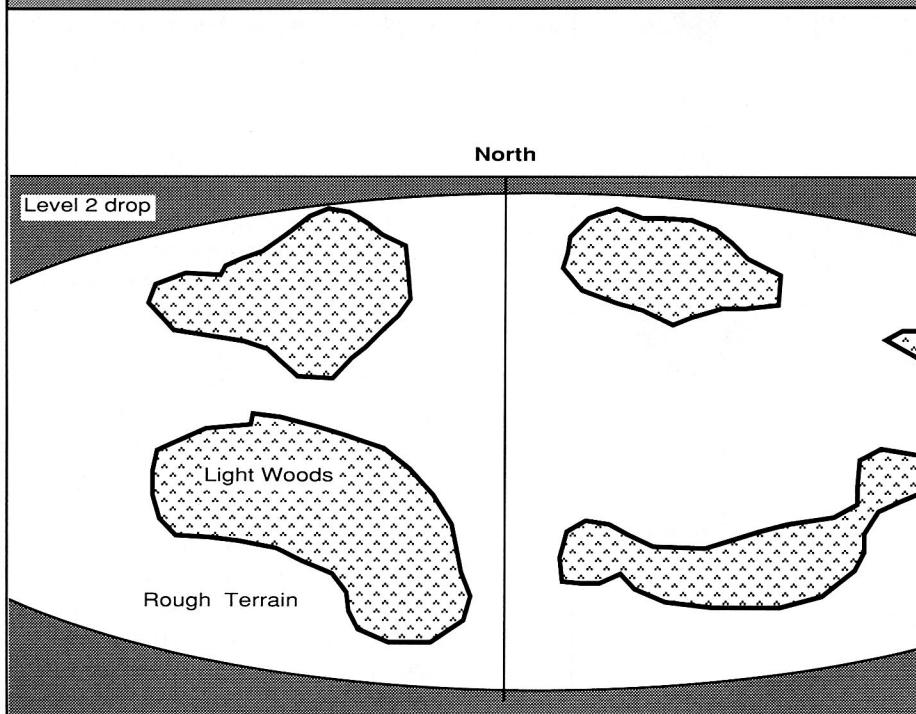

Defenders

Recon Lance of Marik Guard
Lt David Zdlik, *Whitworth*
Piloting 3, Gunnery 4
Sara Sommerson, *Stinger LAM*
Piloting 2, Gunnery 5
Daniel Rolman, *Wasp*
Piloting 4, Gunnery 3
Lisa Guntherson, *Stinger*
Piloting 5, Gunnery 4

Attacker

Infantry Company from Hsien Hotheads
2 platoons, lasers
1 platoon SRM

Victory Conditions

Defender goal: Eliminate opposition.
Attacker goal: Eliminate opposition

Reprinted from the *Arcadia Bee*,
Martin Abel interviewing
Corporal Nate "Deadeye" McBain,
Hsien's Hotheads

Bee: How did you get the name "Deadeye?"

McBain: Because I always aim for one of two parts of a 'Mech — either the head or the back. And I never miss. Each shot only does a little damage — but I never miss.

Bee: How did you happen to be there?

McBain: I was paid to be there.

Bee: Why was your unit there, then?

McBain: We'd heard that the Marik Guard was there with a load of LAM parts. You know how scarce those are. So we wanted them. Makes a nice raid. Funny. They were leaving. We were coming.

Bee: You knew they were moving out...

McBain: No, it was a surprise. More of a surprise to them than to us. I mean, with three aerospace fighters from the oh-so-powerful LAM Marik Guard coming up to meet you for battle there must be something wrong.

Bee: Something wrong?

McBain: Yeah, down on the planet. Either they've all come down with some sort of disease or — they're leaving. Of course we knew they were already there. They hadn't just arrived.

Bee: What kind of tactics does infantry use against 'Mechs?

McBain: Well, I'm part of a foot company myself. So we have the advantage of not having vehicles to inform 'Mechs of our presence, or of using jump packs to reveal our position with an IR signature. We have the advantage of being able to move in just about any direction without being detected. And of course, with lasers and SRMs we can stay out in the field a long time, and do some good damage. And hurt those tin-plated overbearing Mech-Warriors right in their delusions of Godhood.

V T O L



Airmobile (organic to airmobile organization)



Airmobile (possesses own aircraft)



Airmobile (helicopter)

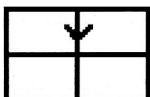

Airmobile Medical / Med Evac



Airmobile Infantry



Airmobile Infantry (aircraft possessing)

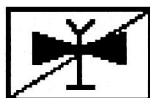

Helicopter / VTOL Gunship

Until the middle of Earth's twentieth century, battlefields were relatively small, isolated areas of armed conflict, which sometimes became static. The trench warfare of the First Global War is an excellent example of this phenomenon. The air support which existed at the time did not coordinate well with ground troops. It was primarily used against stationary targets, such as trenches, barrage balloons, and artillery emplacements. Even with the advancements made in telecommunications and fire-direction equipment during the Second Global War, aircraft were still only used in large strategic strikes or smaller tactical attacks against stationary targets. Only occasionally were small fighter aircraft used in close-support roles, to make tactical strikes against battlefield targets. The German Stuka 87G was one example. Armed with a pair of 37 mm guns, it was used to attack enemy armor on the battlefield.

With the advent of jet aircraft and newer, more mobile armor, it became apparent to those who fought the brush-fire wars which preceded the Third Global War that a new type of aircraft was required to deal with the rapidly shifting battle lines: an aircraft that could strike against the new heavy tanks and infantry units with equal effectiveness; one which could be deployed on a company level, if necessary, and still remain effective. This aircraft was the helicopter gunship.

During the Korean Conflict, helicopters were used to evacuate wounded soldiers, transport troops, and direct artillery fire. They soon realized that arming a helicopter with as little as a single heavy machine gun made it an effective ground support aircraft. By the time of the war in Vietnam, helicopter gunships were quite common. Armed with anti-tank missiles, autocannons, and machine guns, these aircraft were a welcome addition to the fighting forces of every nation in the late twentieth century.

GUNSHIPS

LT RHYS FAIRCHILD

Variant Rules Set 0303

These are optional rules, meant to simulate a largely-neglected fighting vehicle. They are a variant, not yet officially sanctioned. Do not incorporate in your own campaign without due consideration to game balance.

In the 1970's, the first directed-thrust VTOL fighter aircraft came into existence. The British aerospace firm of Hawker-Siddeley produce a combat aircraft which they named the Harrier. Much like present-day VTOLs, the Harrier could take off and land vertically, like a helicopter, by means of its unique system of rotating heat exhaust nozzles. When pointed down, these nozzles provided the lifting force which permitted the Harrier to take off vertically, or if a decreasing amount of thrust was used, to land in the same manner. For horizontal flight, these jets were rotated until they were pointed aft. Their thrust provided forward motion and the Harrier's fixed wings provided lift.

This rotating-nozzle or directed-thrust system permitted the Harrier to take off and land vertically while retaining the speed of a jet aircraft, yet was somewhat inefficient. To generate enough power to lift the aircraft straight up off of the ground required a large amount of fuel, thus limiting the effective flight time of the Harrier. Even so, the Harrier was the first effective vertical take off and landing aircraft. It saw action in most of the conflicts of the late 1900's.

Other types of VTOL aircraft were developed by other companies as time went by. In the late 1980's, a revolutionary type of VTOL was introduced by Rotor Systems Research Company. Using an X-shaped stoppable rotor/wing combination permitted the aircraft to take off and land vertically, to hover like a helicopter, and to fly normally like a jet. Lift for the aircraft was provided by forcing air under pressure out through slots in either the leading or trailing edge of the wing. As the wing is being converted for normal flight, air is alternately blown from the leading edge and then from both edges. When conversion is complete, air is once again forced from the trailing edge. A pair of jet engines provided forward thrust. This type of aircraft, in theory at least, is able to fly much faster than a normal

helicopter, but also requires much more power to maintain its 400 kph speed.

In spite of these, and other advances, such as tilt-wings and tilt-rotors, helicopter/VTOL gunships died out. Fighter aircraft, improved anti-aircraft weapons (particularly those which were man-portable), and tactical battlefield missiles combined to eliminate the role played by gunships. High-mobility armored vehicles, with wire-, radar-, and infrared-guided missiles or autocannons, could now travel with ground troops and provide close support. Fighters armed with "smart" ordinance could deliver precise strikes against remote targets without exposing themselves to infantry ground fire.

Troop transport, medical evacuation, and reconnaissance helicopters were still in common use by most armies. Some were even armed with machine guns mounted on their skids or in their passenger bays, for self-defense or fire suppression while they landed or took off. Of course, the M-Evac helicopters were unarmed.

However, in time even these roles for helicopters were filled by DropShips and electronic reconnaissance equipment. Eventually, the few helicopters that remained in military service were relegated to ferrying officers from one place to another in rear areas, or

Ki-Rin VTOL Gunship

Tonnage:		30
Cruise Speed:	6	
Flank Speed:	9	
Engine Rating:	40	1.5
Type:	Fusion	
Control:		5
Rotors:		3.0
Power Amplifier:		0
Heat Sinks:	12	2.0
Internal Structure:		3.0
Armor:	104	6.5

Location	Points
Front:	27
Lt / Rt Side:	25 / 25
Back:	23
Rotors:	2

Weapons and Ammo:

Type	Facing	Tons
PPC	Front	7.0
Medium Laser	Front	1.0
Medium Laser	Front	1.0
Medium Laser	Rear	1.0
SRM 2	Front	1.0
Ammo (50)		1.0

searching for rebels on worlds with relatively low levels of technology (which kept them from using anti-aircraft missiles).

But now the need has arisen for an aircraft which can make localized attacks against specific targets and still be mobile enough to travel with a unit, a regiment, or a company. The present-day need is for something to bridge the gap between Aerospace fighters and Battlemechs. For a while, Land-Air 'Mechs filled this role by having the speed of a fighter, while being able to hover over the battlefield for an extended period to time. Unfortunately, LAMs are becoming increasingly rare. They are fragile, expensive to build, and expensive to maintain. Also, relatively minor damage can easily cripple a multi-million-C-bill machine. The logical alternative is the helicopter gunship.

In the early summer of 3019,

Goshawk VTOL Gunship

Tonnage:		25
Cruise Speed:	10	
Flank Speed:	15	
Engine Rating:	110	5.25
Type:	Fusion	
Control:		1.25
Rotors:		2.5
Power Amplifier:		0
Heat Sinks:	11	1.0
Internal Structure:		2.5
Armor:	96	6.0
Location	Points	
Front:	25	
Lt/Rt Side:	23/23	
Back:	23	
Rotors:	2	
Weapons and Ammo:		
Type	Facing	Tons
Medium Laser	Front	1.0
Medium I Laser	Front	1.0
SRM 2	Front	1.0
Ammo (50)		1.0
Small Laser	Rear	0.5

Hanse Davion asked the research and development section of the New Avalon Institute of Science to come up with an inexpensive, effective alternative to the now-scarce LAM. Their answer took very little time. Drawing on ancient designs such as the American Apache and the Soviet Hind-D of Earth's war-torn twentieth century, they delivered the specifications for a 25-ton armored VTOL gunship which they named the Goshawk. Since then, all five of the Successor States have begun development of their own VTOL gunships.

The first combat usage of VTOL gunships (or VGs, as they came to be known) was during the battle for McCoomb. The elite Second Ceti Hussars employed two lance of Goshawk VGs against elements of House Kurita's Night Stalkers. In October of 3019, the Draconis Combine sent an invasion force across the border into

Davion space, with the famed Night Stalkers spearheading the operation. They were met by elements of the Second Hussars, and the battle was on. In spite of a stiff defense by the Federation troops, the Kuritas managed to obtain a planet-head and began to land reinforcements and support troops. In the early hours of the morning of October 15, four low-flying, dragonfly-shaped aircraft attacked the field HQ of the Night Stalkers, causing considerable damage. They then faded back into the rocky hills surrounding the Combine encampment, before the confused enemy soldiers could mount a defense.

There were several more attacks of this type over the following two weeks, which resulted in the destruction of two of the Night Stalker's light battlemechs, four armored fighting vehicles, and quite a few soft-skinned vehicles. Twenty-five Combine soldiers were killed, and over a hundred were wounded. One of the four Davion VTOLs was badly damaged. Its pilot was injured by ground fire. In spite of the relatively low number of casualties inflicted on the Kurita forces by the airstrikes, Prince Davion deemed the VTOL gunship program a huge success. The Federated Suns now had a fast-moving, hard-hitting aircraft which could remain over the battlefield much longer than an aerospace fighter, and which could be produced and maintained for a fraction of the cost of a fighter, battlemech, or LAM.

Presently, Davion military policy is to assign two lances, each consisting of two VTOL gunships, to each regiment

of its regular army. These gunships act as regimental close-support aircraft. Davion policy also recognizes the fact that VTOL gunships are by no stretch of the imagination a match for battlemechs. There is a standing order that VGs should not be used to engage 'Mechs frontally unless there is no other choice. Instead, most VGs are used like cavalry vehicles, to attack infantry, armor, and artillery positions, or to support their own ground units or 'Mechs when they are engaged with enemy 'Mechs. Colonel Morgan Graeme of the Sixth Armored Cavalry Regiment has incorporated two VTOL gunship lances into his mercenary company. These new air cavalry units have yet to receive their trial by fire, but Col Graeme has high expectations for the unit.

Of the five Successor States, only the Federated Suns, the Lyran Commonwealth, and the Draconis Combine are using VTOL gunships to any great degree in their regular armies. Only a few of the larger or more well-known mercenary units, such as the Eridani Light Horse, the Twenty-First Centauri Lancers, and Wolf's Dragoons are have included VGs in their tables of organization and equipment. All five of the Successor States and most mercenary companies have been using VTOLs for some time for transportation, Med-Evac, Recon, and the like.

House Steiner has organized its VGs into company-level units, which they call flights, each being made up of six aircraft, their air and ground crews, and various support personnel. Two of these units are attached to each division of a task force or garrison. Each flight retains its own Independent command structure and is responsible only to the task force or garrison commander.

The Draconis Combine assigns one lance of VTOL gunships to every company of 'Mechs. This practice is something of a two-edged sword. On the plus side, the VGs are more clearly

integrated with the troops they are to support, the response time between the request for an airstrike and the arrival of the aircraft is small, and a certain rapport is established between the ground troops and the air crews. The drawbacks to this arrangement are the huge number of gunships required to cover all assignments and the often-inept use of VGs by the company leaders. Once, a Combine major ordered his VG lance to attack a strong point held by a medium lance of Steiner 'Mechs. The Kurita 'Mechs had made three attempts to take the strong point, but were repulsed every time. Finally, the company commander ordered his gunships to strafe the entrenched Steiner 'Mechs. When the VGs made their first pass, unsupported by the attached ground forces, every Lyran gun opened fire on the aircraft. Both VGs were destroyed by Steiner anti-aircraft fire. (Miraculously, one of the pilots survived with no more injury than a broken nose.) The episode left the Lyran forces with tactical air superiority in the entire sector.

Attaching a few lances of VGs to a division of battlemechs enables a unit commander to provide his troops with local tactical air-support, with a much lower response time than that of an aerospace fighter strike.

As VTOL gunships became more common, new tactics were developed. One of these new, or rather rediscovered, tactics is the "pop-up". A pilot hides his VTOL behind a line of hills or a similar terrain feature. Usually the VTOL will sit on the ground with its engine running, using its sensors or a spotter to detect the approach of the enemy. As the enemy comes into range, the gunship pilot quickly raises his machine above the level of the hill, fires, and drops back down into cover. Then, using the terrain as a screen, the VG withdraws to the next suitable place of concealment, and begins the whole process over again.

In the hands of an experienced

pilot, VTOLs have the ability to fly in a manner referred to as "nap-of-the-earth". This means that a VTOL pilot may fly his ship very low to the ground, under enemy radar, hugging trees, hills, and other terrain features for cover. Flying "nap-of-the-earth" is something of a hazardous proposal. A slight miscalculation on the part of the pilot can lead to disaster, leading the VTOL to crash into the terrain feature it was skimming across. Combining "nap-of-the-earth" flying with the "pop-up" attack gives a VTOL gunship an excellent chance of surviving while retaining the ability to make fast, effective strikes.

One of the most successful and noteworthy VTOL gunship pilots is Captain Alan I Cameron of the Federated Sun's Second New Syrtis Fusiliers. During a deep penetration raid on the Liao-held planet of Wei, the Second Fusiliers were detailed to cover the withdrawal of the raiding forces. Cameron's VG lance, consisting of two 30-ton Wyvern VG's (see page 49), flew "nap-of-the-earth" through a deep, narrow valley, and popped up at its end, right in the middle of the HQ lance of the defending Liao 'Mech units. Cameron and his wingman, Lt Scott Davis, flew low through the enemy 'Mechs, wreaking havoc and causing total chaos among the shattered Cappellans. The Liao 'Mech pilots dared not fire at the

Iroquois Transport VTOL

Tonnage:		15
Cruise Speed:	9	
Flank Speed:	14	
Engine Rating:	40	2.0
Type:	ICE	
Control:		0.75
Rotors:		1.5
Power Amplifier:		0
Heat Sinks:	10	0
Internal Structure:		1.5
Armor:	100	6.25

Location	Points
Front:	8
Lt/Rt Side:	7/7
Back:	4
Rotors:	2

Weapons and Ammo:

Type	Facing	Tons
Pasenger Bay	-----	7.0
Machine Gun	Front	0.5
Ammo (100)		0.5

marauding VGs for fear of hitting each other, while Cameron and Davis were free to shoot at everything in sight.

Just before the Davion gunships withdrew, Cameron spotted a red and yellow VTR-9B Victor hanging back from the battle. Skimming along the ground, Cameron closed with the 'Mech, avoiding its fire with short zigzags until he was at point-blank range. At under 60 meters, Cameron pulled his Wyvern up and fired. After-action reports and a review of the film from Cameron's gun cameras revealed that both lasers and all four round from his SRM launchers struck the Victor's head, blowing it off and killing the pilot, Commandant Albert Fong of the Third Battalion of the Second Kearny Highlanders. In the confusion that followed, Cameron and Davis escaped down the same valley they had used to approach. Cameron was promoted to Major. He and Davis were decorated for their part in the raid.

Cameron was also credited with a solo kill on the Liao Victor — the first time a VTOL gunship had singlehandedly destroyed an assault 'Mech.

As mentioned earlier, VTOLs can be used for many other battlefield tasks. Troop and cargo transportation, evacuating wounded soldiers, and reconnaissance are only a few non-combat roles played by VTOLs.

By eliminating the heavy weapons systems and installing provisions for carrying passengers, the average VTOL can transport as much as a platoon and its equipment. In situations where rapid deployment of infantry is necessary, and DropShips are unavailable or not feasible, VTOL transports are the ideal substitute. The Iroquois, for example, has a cruising speed of 90 sph and can ferry up to seven tons; the weight of a full infantry platoon plus equipment. However, most transport VTOLs are not large enough to carry a platoon. Usually

the maximum capacity for a troop transport VTOL is two seven-man squads and their equipment. A lance of aircraft possessing air-mobile infantry generally consists of two ten-ton transport VTOLs, their air and ground crews, and one twenty-eight-man infantry platoon. There are a few larger transport VTOLs, like the thirty-ton Skyhook, which are capable of transporting infantry, cargo, or even light vehicles.

An air-mobile infantry assault usually goes like this: aerospace fighters or VTOL gunships stage an air-strike against the proposed landing zone, while the transports are still approaching. Once enemy activity in and around the landing zone has been suppressed, the transports move in and begin to land their troops. As a general rule, only one or two VTOLs are on the ground at one time. The other VTOLs involved in the landing circle the landing zone in case their armament is required to further suppress enemy activity. As the

VTOLs on the ground disembark their passengers and take off, the ones next in line move in to take their place.

In theory, at least, this technique of landing air-mobile troops will permit the most rapid deployment of infantrymen, while exposing the VTOLs to as little danger of being caught on the ground as possible. The same basic process is used for extracting air-mobile troops already on the ground.

Special Forces teams like the Federated Suns' Broadsword teams or House Kurita's DEST have been known to use VTOLs extensively in their operations. These elite units are even trained to abseil from a hovering VTOL if the terrain below does not provide a safe landing area.

Most field hospitals and MASH units include med-evac VTOLs in their tables of organization and equipment. The critical seconds saved by shipping a wounded soldier by air rather than by ground vehicle often mean the difference between life and death to a badly injured man. The most commonly used med-evac VTOL is the ten-ton Lifesaver. Lightly armored, with a cruising speed of 100 kph, the Lifesaver carries a 3.5-ton medical bay with enough space to carry a doctor, two nurses, and eight patients, as well as medical supplies and equipment. If necessary, the Lifesaver medical crew can even perform emergency surgery in the VTOL's medical bay. (This is seldom done, because the aircraft must be on the ground. The shuddering of a VTOL in flight would make the simplest surgical procedure impossible.)

In a rare example of selfless heroism, the crew of a Free Worlds League med-evac VTOL risked their lives to give aid to two wounded soldiers of the Lyran Commonwealth. During a lull in the fighting at the Battle of Fairchance, on the Marik-held world of Galeisto, a Marik Lifesaver VTOL was called in to pick up the wounded members of a Northwind Highlanders infantry platoon.

Lifesaver Medical-Evacuation VTOL

Tonnage:		10
Cruise Speed:	10	
Flank Speed:	15	
Engine Rating:	50	3.0
Type:	ICE	
Control:		0.5
Rotors:		1.0
Power Amplifier:		0
Heat Sinks:	10	0
Internal Structure:		1.0
Armor:	16	1.0
Location	Points	
Front:	5	
Lt/Rt Side:	3 / 3	
Back:	3	
Rotors:	2	
Weapons and Ammo:		
Type	Facing	Tons
Medical Bay	—	3.5

toon. While the VTOL was on the ground, a Lyran corporal approached under a truce flag. The Lyran soldier explained that he had two seriously injured men at an aid station about half a kilometer away who would die without immediate medical attention. The Marik surgeon, a Captain Wilma Daranovich, detailed one of her nurses and one of the League corpsmen to go with the Steiner NCO to the aid station. The medical team reached the aid station and brought the wounded soldiers back to the VTOL. Dr Daranovich, after examining the Lyran casualties, decided that they probably wouldn't survive the flight to the Marik field hospital 25 kilometers away. Leaving a corpsman to treat the less critically wounded patients, Dr Daranovich set up the Lifesaver's emergency operating room. Working as quickly as possible, the Free Worlds medical team struggled to stabilize the wounded men's condition. The VTOL was grounded for almost three hours, while long range missiles and artillery rounds from both sides screamed overhead. Finally the casualties were stabilized and the Lifesaver took off. Overloaded and low on fuel, the craft would never reach its own MASH unit. Switching to the Lyran Communications band, the pilot put in a call asking for the location of the nearest Steiner field hospital. By chance, a Lyran MASH truck had just established a field hospital five kilometers away. The Free Worlds Lifesaver landed at this hospital. They were helped to treat their own wounded in the Lyran operating room. Once all of the casualties had been treated, including a number of new Steiner wounded, the Marik VTOL was permitted to refuel and leave unmolested.

Janos Marik himself issued a unit citation for bravery to Dr Daranovich and her crew. Lt-Col N James Oliver, commander of the Lyran field hospital, sent a letter of commendation to Dr Daranovich via ComStar.

VTOLs are also used for short

range reconnaissance missions. Replacing weapons with sophisticated detection and recon equipment enables the VTOL to direct artillery, spot for counter-battery fire, and perform surveillance work. Recon VTOLs are usually small and fast, and carry only lightweight armor and defensive weapons. Many recon VTOLs are of the tilt wing/rotor or the stoppable rotor/wing variety. This lets them fly at higher altitudes than standard rotary-wing aircraft, taking them out of range of many infantry launched anti-aircraft missiles.

As time goes on and new innovations are made, we shall certainly see changes in the use and applications of VTOL aircraft. Shortly after VTOLs were first deployed, pilots discovered that they, like any other armed aircraft, have some ability to strafe ground targets. While their strafing runs are not as effective as those made by aerospace fighters, they do give VTOL gunships an extra weapon in their bag of tricks.

One very recent development is the addition of what is referred to as a "chin-turret". Currently installed only on the experimental Kurita-built XV-227 VTOL gunship, the chin-turret provides a 300° field of fire to the weapons it houses. Unfortunately, the turret itself weighs a ton and can only mount a weapon weighing a half-ton or less. There have also been some problems with the power and ammunition feed systems between the body of the VTOL and the turret weapon. In the case of a machine-gun mount, the flexible ammunition feed track has developed the habit of twisting and eventually breaking under the stress of the turret's rotation. Small lasers, on the other hand, have the flaw of having their power supply cables separate and

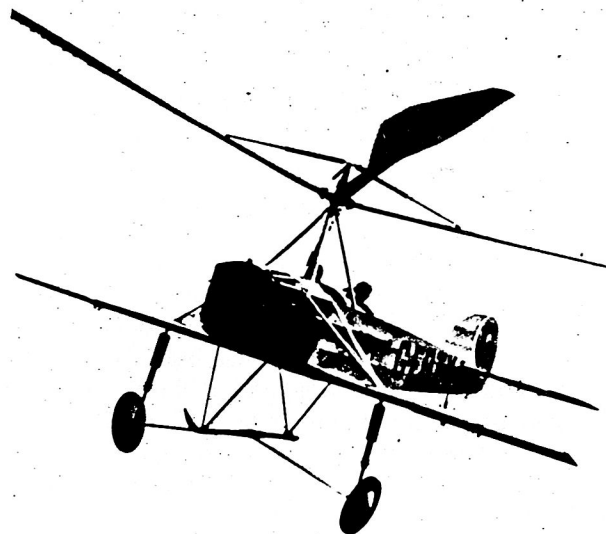

An early version of the VTOL

short out at the connection between the VTOL's airframe and the turret spindle. If the bugs can be worked out of this experimental program as quickly as the general staff on Luthien says, we may see chin turrets become a common component on attack VTOLs.

Considering the ever-increasing amount of military activity in the Inner Sphere, the need for tactical air-support is fast becoming a pressing matter to the members of all military communities. As the availability of the already-scarce LAM continues to decrease, we can expect to see an increase in the usage of Vertical Take-Off and Landing aircraft by all of the Successor States' armed forces, in both combat and noncombat roles.

Lieutenant Rhys Fairchild served three years with the tactical aerospace division of the Eighth Ceti Hussars. After being badly injured in an accident during a training exercise, which also destroyed his Wasp LAM, he was transferred to the research and development section of the New Avalon Institute of Science. Lt Fairchild is currently working as a design consultant on the VTOL gunship program.

Gunship Simulator

On May 17, 3026, Captain Alan I Cameron and his wingman, Lt Scott Davis, engaged HQ elements of the third battalion, Second Kearny Highlanders. Pitting their 30-ton Wyvern VTOL gunships against a numerically and tactically superior force, Cameron and Davis disrupted the command structure long enough to allow the Second New Syrtis Fusiliers, first battalion, to escape, after raiding the 'Mech production facility on Wei. In this engagement, Cameron personally destroyed a VTR-9B, identified as the command 'Mech belonging to Commandant Albert Fong, CO of the third/Second Highlanders. Thanks to the courage and daring of Captain Cameron and Lt Davis, the Second Fusiliers were able to escape with few casualties

— excerpt from after-action report:
Wei raid, Second New Syrtis Fusiliers.

In order to more fully understand the battlefield applications of VTOLs and VTOL gunships, Lt Fairchild has developed the following program for the BattleTech Combat Simulation System. This program is a recreation of Captain Alan I Cameron's raid on Commandant Albert Fong's HQ lance. **Mapboard used:** Basic BattleTech mapboard. Treat all water hexes as level O ground. Hexes 0115 to 0317 inclusive are treated as the opening of a narrow valley. Treat this valley as one level below ground level for purposes of targeting. Only VTOLs or jump-capable 'Mechs may enter these hexes due to the sheer sides of the valley.

Forces used:

Attacker: elements of the tactical aerospace division of the Second New Syrtis Fusiliers.

Captain Alan I Cameron *Wyvern VG*
Pilot 3, Gunner 3, Leadership 2, Tactics 2
Sergeant Scott Davis
Pilot 2, Gunner 2

Defender: headquarters lance of the third battalion, Second Kearny Highlanders.

Commandant Albert Fong *Victor* Hex 1003
Pilot 2, Gunner 3, Leadership 4, Tactics 3
Lt Jefferson Wills *Shadow Hawk* Hex 1207
Pilot 2, Gunner 2
Cpl E.J. Morin *Assassin* Hex 0906
Pilot 1, Gunner 1
Pvt Mary Dakis *Locust* Hex 0910
Pilot 1, Gunner 1

All of the 'Mechs in the HQ lance have sustained some damage during the fighting earlier in the day. Fong's Victor has lost 16 points from its right front torso and 8 from its left leg. It has only 8 rounds left for its autocannon, and 10 rounds for its SRM 4. Wills' Shadow Hawk's autocannon has been disabled and its left arm and left front torso suffered 9 points of damage, while its left torso has taken 8. Its LRM 5 and SRM 2 have 19 and 21 rounds left respectively. Dakis' Locust has taken 7 points of damage to its right leg, and the left arm machine gun is damaged. There are 150 rounds left in the MG magazine.

The defender sets up and moves first. Attacker enters the board through the valley hexes (0115 through 0317) on turn one.

Objective: The Davion VTOL gunships are to tie up the Liao HQ lance until the raiders can withdraw.

Victory Conditions:

Attacker: Engage the Liao 'Mechs for eight turns and escape through the valley with at least 1 VTOL.

Defender: Destroy both Davion VGs before the end of turn 8.

Special Rules:

1) For each Liao 'Mech destroyed or disabled, the Davion VTOLs can subtract one turn from the length of time for which they are required to tie up the 'Mechs.

2) Due to the reluctance on the part of the Liao 'Mechwarriors to fire at the VGs when it was possible that such fire might hit their friends, any time a Liao 'Mech is in the same line-of-fire as the target VG, the Liao pilot must roll a 7 or better on 2d6 before he fires. (The Liao player may add his gunnery skill level to that roll.) If he fails the roll, that particular 'Mech may not fire on that VTOL in that game turn. If he makes the roll, a normal "to-hit" roll is made. If the shot misses, a second "to-hit" roll must be made. If the second roll is a hit, the shot misses the friendly unit also. If the second roll indicates a miss, the shot hits the friendly 'Mech, and is handled like a normal hit on an enemy.

3) Because of the sudden appearance of the Davion gunships, the Liao forces were taken by surprise. To represent this, the Liao 'Mechwarriors may not fire or make physical attacks during the first turn. Beginning on the second turn, the Liao 'Mechs may fire at will, subject to special rule #2.

Modifications to the basic BattleTech Simulator Rules:

Strafing: VTOL gunships share the ability of aerospace fighters to make somewhat limited strafing runs. In order for a VG to make a strafing run, it must declare its intention to strafe before expending any MP that turn. The "strafing row" of a VG's strafing run is only 1 hex row wide, and is only as long as the VTOL's maximum number of MPs available that turn. The VTOL may not make any other movement that turn besides the strafing run. That is, a VTOL with a current flank speed of 9 MP may make a strafing run affecting an area 9 hexes long and one hex wide. The strafing run affects all targets in its strafing row, modified by the pilot's gunnery skill and the condition of the aircraft. As with an aerospace fighter, all of a VTOL gunship's "strafing weapons" may fire at the targets in the strafing row. Strafing weapons include all lasers, PPCs, and machine guns which are mounted facing forward. "Non-strafing weapons", which are defined as autocannons and all missile launchers, may fire once per strafing run at one specific target in the strafing row.

Strafing runs may not be conducted while flying "nap-of-the-earth".

Ground fire against a strafing VTOL gunship is treated much in the same manner as fire against a strafing fighter. Ground units have a basic "to-hit" number of 8 plus, with a minus two modifier if the firing unit is in the strafing row.

Chin turrets: As mentioned in the article, the Draconis Combine has begun experimenting with mounting small "chin-turrets" under the nose of their VTOL gunships. Although they are still in the experimental stages and somewhat unreliable, chin-turret design specifications are included here. Chin turrets may only be mounted on VTOLs weighing 20 tons or more. The turret itself weighs 1 ton and may house a weapon weighing no more than 1/2 ton (a machine gun or a small laser).

Chin turrets provide a 300° field of fire only to the weapon mounted in them (see Diagram A).

Any time a chin turret is rotated (during the same phase as a 'Mech would swivel its torso), 2d6 should be rolled. An 11 or 12 indicates that the turret has jammed on its track; it may not be rotated again until it is repaired by the pilot, or by a technician while the VTOL is on the ground. The turret is considered to have jammed at the end of its rotation, and the weapon mounted in it may fire only along that facing until the turret is repaired.

Any time the turret-mounted weapon fires, 2d6 should be rolled prior to the "to-hit" roll. A result of 10, 11, or 12 indicates that the ammunition or power feed devices have failed. The turret-mounted weapon may not fire again until repaired.

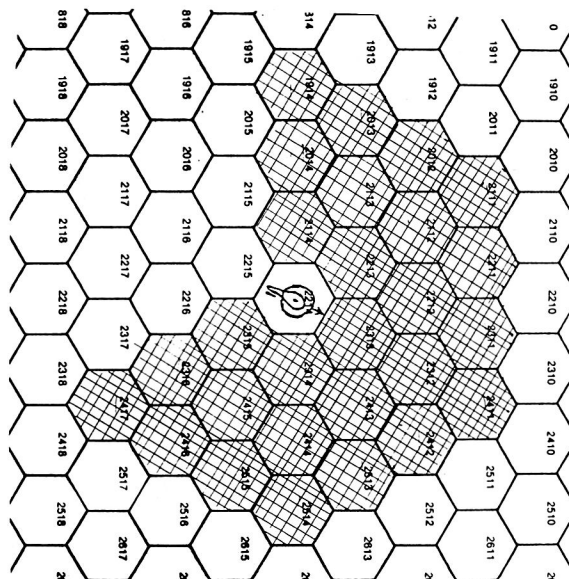

Wyvern VTOL Gunship

Tonnage:		30
Cruise Speed:	9	
Flank Speed:	14	
Engine Rating:	130	6.75
Type:	Fusion	
Control:		1.5
Rotors:		3
Power Amplifier:		0
Heat Sinks:	10	0
Internal Structure:		3
Armor:	100	6.25
Location	Points	
Front:	28	
Lt/Rt Side:	24/24	
Back:	22	
Rotors:	2	

Weapons and Ammo:

Type	Facing	Tons
Large Laser	Front	5.0
Medium Laser	Front	1.0
Small Laser	Rear	0.5
SRM 4	Front	2.0
Ammo (24)		1.0

The Last Word

"Helicopters present no serious threat to battlemechs."

— Cdt Albert Fong,
Second Kearny Highlanders

Technical Readout

LYN-5X LYNX

Overview

The Lynx was designed at Kallon Industries by a group of expert Technicians and MechWarriors in response to a Star League contract issued in 2736 after studies of combat reports of the early battles between Star League units and the rebellious Periphery states. These reports indicated a need for a 'Mech with more firepower in the medium weight class, since it appeared that firepower and protection were superior to mobility in many of the situations that the Star League armies were face with. Kallon Industries modified their Wolverine chassis to meet the contract demands, and in doing so, were able to get their design into production ahead of the competition. The Kallon production lines, already filled with the popular Rifleman and Wolverine designs, did not build very many examples of the Lynx. Only 2,500 examples were built, and it is a testimony to the basic soundness of the design that 80 of them continue to soldier on in the Inner Sphere. Over 1,000 examples left the Inner Sphere with Kerensky when he went into exile. The production lines were destroyed early in the First Succession War, though there are rumors that Defiance Industries of Hesperus II has obtained a rare copy of the Lynx to study in order to undertake production in the near future.

Capabilities

The Lynx has been nicknamed "The Medium 'Mech that thinks it's a heavy". Its design staff insured that the 'Mech would be easy to maintain and that modular components were used

throughout its construction. It also ensured that the Mechwarrior had a comfortable environment and good firepower at all ranges. Its Maximilian 65 armor is the heaviest armor that one can find on a medium 'Mech. Its Tek BattleCom communications system makes it a useful command vehicle for Medium Lances or in Regimental Command Lances.

In the Lynx, the Wolverine chassis underwent only slight modification. The SRM-4 and a medium laser were installed where the SRM-6 launcher is on the Wolverine. The ball turret was done away with in response to complaints from 'Mechwarriors concerning the restricted vision from the cockpit, and from Techs complaining about the turret's maintenance time. A drum LRM-5 launcher similar to the Shadow Hawk's was mounted on the right torso. The Lynx's drawback is its lack of jump jets and relatively slow speed for its size.

In actual battle conditions, however, the Lynx makes up for its lack of mobility by its heavy armor and heavier firepower.

Variants

The LYN-6X variant removes the missile racks and replaces them with a large laser in the left torso and adds one heat sink in the right torso. This variant was designed with raiding and guerilla warfare in mind, since it would not be dependent on missile reloads. The LYN-7X removes the LRM rack in favor of 4 jump jets and an additional heat sink. This variant was designed for hard fighting in rough terrain, where

jump jets would be necessary for mobility. Neither variant was produced in large quantities; it is estimated that less than 15 each of these types still exist in the Inner Sphere.

Notable 'Mechs and MechWarriors

Captain Steven Fortna With 24 'Mech kills, including an Atlas, and credit for two Demolisher tanks; Capt Fortna is the most successful MechWarrior in the Horsemen of the Apocalypse mercenary unit. He is respected within the unit for his tactical ability and his bravery. He is known for standing fast against much larger enemy units to enable the rest of his company to execute the effective "Block and Sweep" tactic.

LYN-5X LYNX

Type: LYN-5X LYNX

Mass: 55 Tons

Chassis: Crucis-B

Power Plant: DAV 220

Cruising Speed: 43.2 kph

Maximum Speed: 64.8 kph

Jump Jets: None

Jump Capacity: None

Armor: Maximilian 65

Armament:

1 Kreuss Particle Projection Cannon

1 Conan / S LRM-5

1 Hovertec Short Range Missile Quad

3 Magna MkII Medium Lasers

Manufacturer: Kallon Industries

Communications: Tek BattleCom

Targeting and Tracking System:

Garret T11C

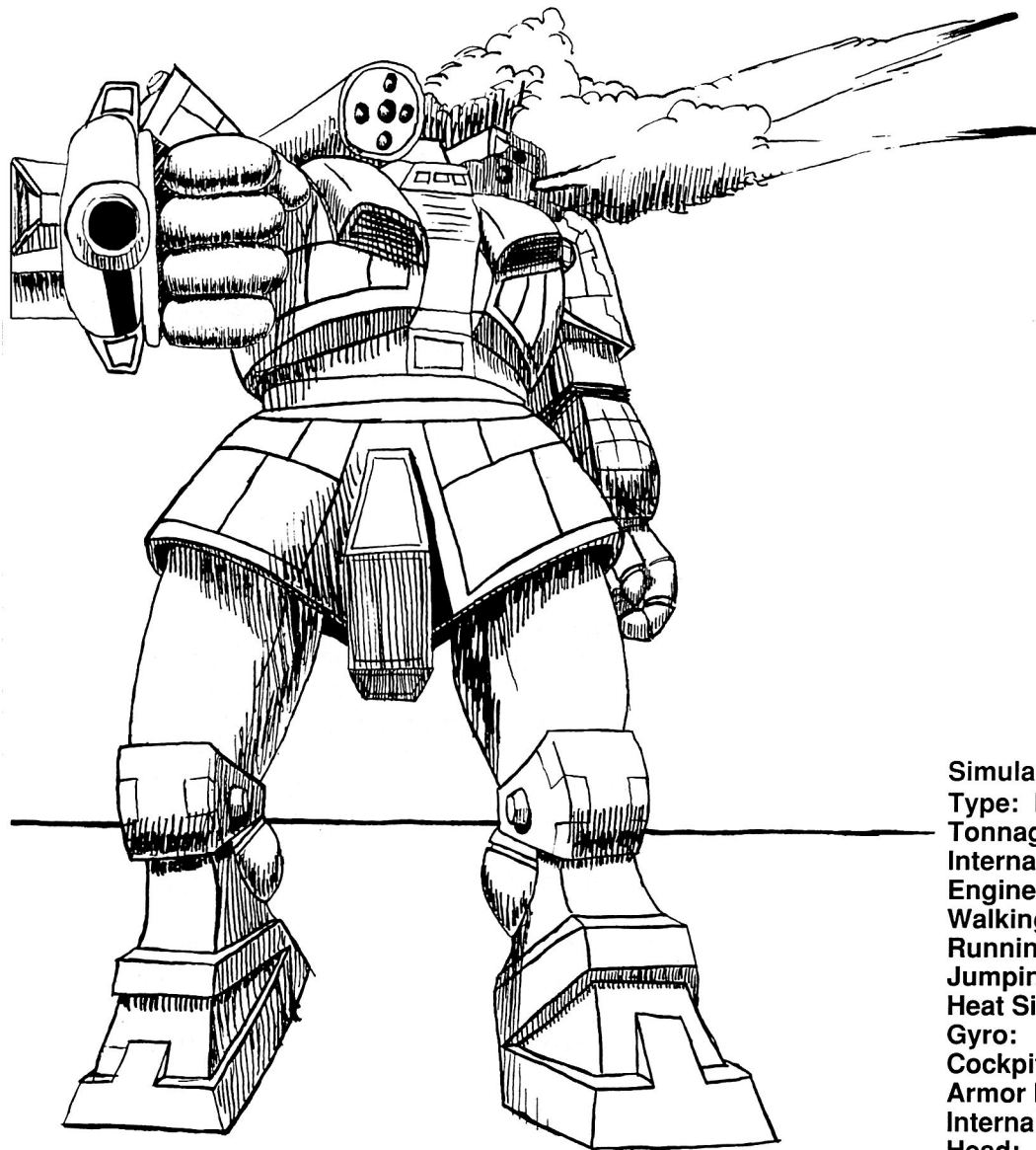

Simulator Stats:

Type: LYN-5X LYNX

Tonnage: 55 Tons

Internal Structure:

Engine: DAV 220

Walking MPs: 4

Running MPs: 6

Jumping MPs: 0

Heat Sinks: 17

Gyro:

Cockpit:

Armor Factor: 168

InternalArmor	Structure	Value
Head:	3	9
Center Torso:	18	25/10
Rt/Lt Torso:	13	20/6
Rt/Lt Arm:	9	16
Rt/Lt Leg:	13	20

Head: 3

Center Torso: 18

Rt/Lt Torso: 13

Rt/Lt Arm: 9

Rt/Lt Leg: 13

Tons

55

5.5

10

7

3

3

10.5

Weapons and Ammo:

Item	Location	Critical	Tons
PPC	RA	3	7
SRM-4:	LT	1	2
AMMO			
SRM-4: (25)	CT	1	1
LRM-5: (24)	CT	1	1
LRM-5:	RT	1	1
Medium Laser:	LA	1	1
Medium Laser:	LA	1	1
Medium Laser:	LT	1	1

Assault on Jump-Station Kusari

Game Set-Up

This scenario uses Expert BattleTech and CityTech rules and one CityTech map. Terrain effects are as shown, with the following exceptions: All Pavement hexes are considered to be Elevation -1 Clear Terrain (i.e., they form a shallow depression *below* the surrounding Elevation 0 Terrain), all Water hexes are considered to be Elevation 0 Clear terrain, and all Woods hexes are considered to be Rough Terrain.

The setting is the Ti Plains region on the Kusari planetoid in the belt region of the Weisau system. The Attackers are a reinforced Fire Lance from Galt's Grenadiers, a mercenary unit in House Kurita's employ. The Defenders are a mixed force of two light BattleMech lances from the 3rd Ceti Hussars and several attached platoons of Davion jump infantry. The Attacker's objective is to eliminate all Defending 'Mech units. The Defender's objective is to prevent the Attackers from meeting their objective. After initial placements are made, the Defenders set up first.

Initial Placements

The Attacking player begins by placing a total of 10 hexes' worth of Medium Buildings within the Elevation -1 Terrain *only*. The buildings may be interconnected and/or multi-hex, but they may not be multi-story. The Attacker then places the JumpShip navigational transceiver antenna (using an unusual vehicle counter to distinguish it from other structures). This antenna may be placed in any non-Rough hex within three hexes of any Medium Building hex, and it renders that hex wholly impassable to 'Mechs and vehicles. Finally, the Attacker secretly records on which map edge his force will arrive.

Defender

After initial placement, the Defender may set up his BattleMechs and jump infantry platoons anywhere on the Mapsheet, including within the buildings (none may be placed in the antenna hex, however). The jump infantry available will total 2D6-3 (minimum of 2) platoons. To determine how each platoon is armed, roll 1D6 for weaponry and record the following results: on a roll of 1-2, rifles; on a roll of 3-4, machine guns; on a roll of 5, portable lasers; on a roll of 6, SRMs. The number of platoons and weaponry types should be made known to the Attacker, but not the nature of each individual platoon's secret weaponry (only the totals).

2nd Battalion, 73rd Davion Jump Regiment (elements)

Two to nine infantry platoons, equipped as described above.

A Company, 1st Battalion, 3rd Ceti Hussars (elements):

One *Enforcer* (Piloting 4, Gunnery 3)

Four *Valkyries* (Piloting 5, Gunnery 4)

One *Stinger* (Piloting 5, Gunnery 4)

One *Wasp* Piloting 5, Gunnery 4)

One *Locust* (Piloting 5, Gunnery 4)

Attacker

After the Defender has placed his forces, the Attacker's BattleMechs must enter the Mapsheet on the map edge recorded earlier, with all 'Mechs expending their maximum movement (beginning with the first map hex entered). All Attacking 'Mechs must enter from along the same map edge on Turn 1.

Galt's Company Fire Lance (reinforced):

Lt Ludmilla Janonka's *Quickdraw* (Piloting 3, Gunnery 1)

mW Sandusky Sorrell's *Shadow Hawk* (Piloting 3, Gunnery 3)

mW Malcolm Wingu's *Trebuchet* (Piloting 3, Gunnery 3)

mW Kali Konishi's *Dragon* (Piloting 6, Gunnery 4)

mW "Crazy Jack" Deever's *Shadow Hawk* (Piloting 3, gunnery 2)

Victory Conditions

The scenario ends when all BattleMechs of either side have been destroyed, incapacitated (rendered incapable of movement), or withdrawn off the Map Sheet. Both players may retreat their 'Mechs off any map edge anytime during the scenario, but 'Mechs withdrawn in this manner may not return.

The Attacker receives 2 VP for each destroyed or incapacitated Defending 'Mech, and 1 VP for every jump platoon-equivalent destroyed (i.e., 1 VP

1400 Hours, 18 May 3029, Ti Plains, Kusari Planetoid, Weisau System

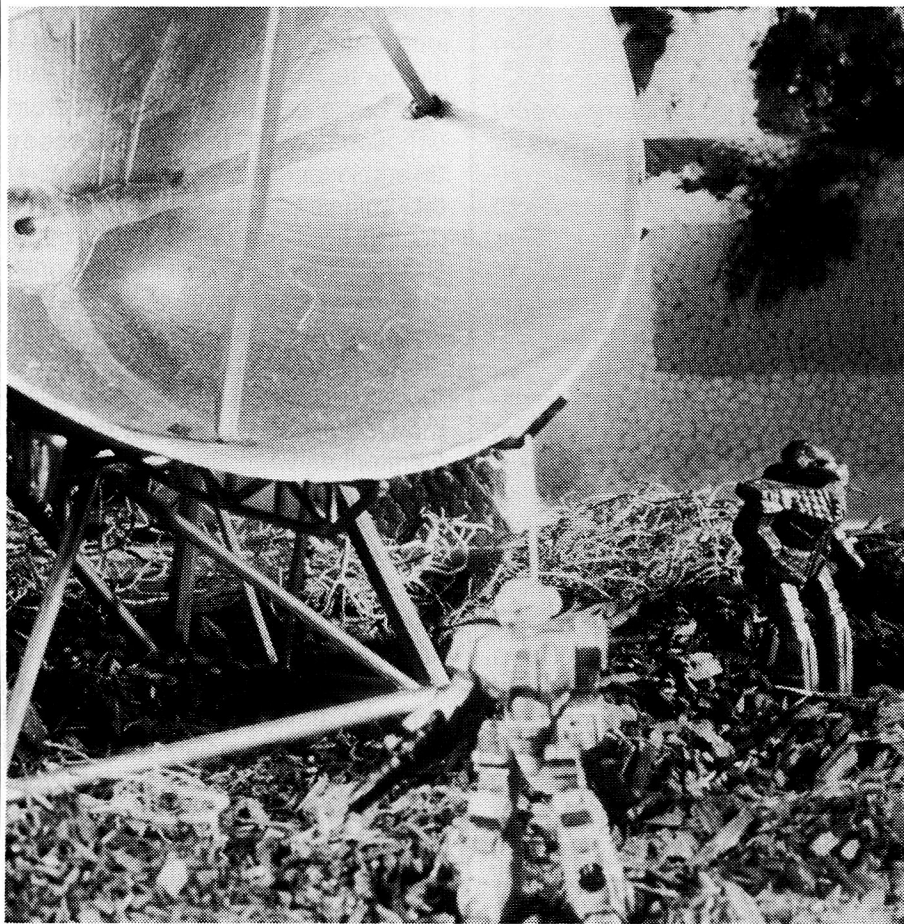

for every 21 infantry casualties, rounded down). The defender receives 3 VP for every enemy 'Mech that is withdrawn off the Map Sheet. In addition, the Attacker receives 20 VP if the Defender knocks out the antenna; the Defender receives 10 VP if the Attacker knocks it out.

If the Attacker has at least twice as many victory points as the Defender, the Attacker wins a strategic victory. If the Attacker has more points than the Defender, the Attacker loses (in which case the Defender may have won a tactical or strategic victory, as described above).

Special Rules

The navigational antenna should be treated as a Light Building for purposes of withstanding damage. If the antenna suffers damage equal to *half* its Construction Factor, it is considered to be inoperational. Likewise, if *any* 'Mech (regardless of weight) walks, runs, or lands on the antenna, it is knocked out. The antenna effectively fills up the entire hex; no 'Mech (or other vehicle, for that matter) may enter the hex without crippling the antenna. A single infantry platoon may occupy the same hex without effect,

Death from Above

The Defender cannot employ the "Death from Above" BattleMech tactic (the Defending unit is considered to be untrained in this procedure). If the Attacker ever conducts a "Death from Above" attack during this scenario *and if* it is successful the first time it is attempted, no Defender 'Mechs may take any form of action during the next turn. This paralyzing effect only applies to the first time the tactic is attempted, and only then if the attack is successful. Success on any subsequent attempts will have no effect.

Suggested Variants

The simplest ways to increase the Defender's chances of winning would be to allocate larger quantities of infantry, to assign more effective platoon weapons, or to do both. Another possibility, if both players are familiar with anti-'Mech infantry rules as described in The BattleTech Manual, would be to exchange Defending SRM-equipped jump platoons for anti-'Mech rifle platoons on a one-for-one basis (maximum of three platoons). For each platoon received, the Attacker gets 1 additional VP at the end of the scenario (this reflects the relative cost in committing such rare and expensive units to the defense).

The simplest way to increase the Attacker's chances would be to decrease the number of Defending 'Mechs, and/or eliminate the Defending infantry entirely.

Touch Not the Wolf

Benjamin: January 22, 3026

On this date Col Jaime Wolf, commanding officer of Wolf's Dragoons, a top-of-the-line mercenary unit five Mech regiments strong, received the Order of the Bushido Blade from Coordinator Takashi Kurita. They discussed a renewal of the unit's contract. Since then, the unit has been cut to 20% of its former strength by bloody warfare with House Kurita. What happened since that promising ceremony?

What person or incident began the weakening of Takashi Kurita's faith in the Dragoons? Warlord Grieg Samsonov's envious ambition, with its consequences of verbal and supply-side harrassments? The failure of message equipment between the worlds where the Dragoons were stationed? ComStar's unexplained dislike of Col Wolf? The difference in styles of military discipline between the Dragoons' demarcation of work and private life and the sacred duty of the DCMF?

Samsonov early made it his business to make the Dragoons' position as difficult as possible, reassigning sympathetic—or even competent—liason officers, issuing arbitrary commands which violated contractual rights, and at the last manufacturing atrocities on the Dragoons' Kurita base world of An Ting which caused the population to attempt the wholesale slaughter of the unit. If in fact the unit's covert section is responsible for the assassination of Grieg Samsonov (and evidence suggests otherwise), who can blame them?

In order to get the Dragoons' dependents away from Combine space without fullscale war, Col Wolf needed a diversion. He found it only by paying a deadly price. A formal challenge was issued: *Send the best of House Kurita's*

forces to meet us on the barren planet of Misery. There we will duel, fighting force to force to decide this issue honorably. The challenge was accepted; the dependent non-combatants were dispatched to safety. The honorless Samsonov tried to have these innocents killed en route, but his own warriors' honor defeated his plan.

On Misery, Wolf's Dragoons initiated a long series of 'Mech to 'Mech formal duels. Coordinator Takashi Kurita had added injury to insult by assigning the friendly Wolf-trained *Ryuken* as the Dragoons' opponents. Honorable men fought and killed one another, hating the necessity. At last, the Dragoons provoked an assault on a previously fortified position and the real war began. After a month-long bloodbath, Wolf's Dragoons emerged as winners, but at the cost of half their 'Mechs and over half of their 'Mech pilots. Zeta Battalion, which had taken the most damage of all, was sent to ensure the noncombatants' safety. They left under protest.

The Dragoons lifted from Misery, severely battered, but with honor restored. They left behind an old friend, General Minobu Tetsuhara. This commander of the *Ryuken* felt compelled to commit ritual suicide as an apology to the Coordinator for losing. Col Wolf felt this as a personal loss.

They were met on a base in the Harrow's Sun system by the agent of their new employer—Lt General Ardan Sortek, trusted advisor to Prince Hanse Davion. The Dragoons had entered the employ of the Federated Suns just as the Fourth Succession War was about to begin. Offered six months to refit and heal on Robinson, Col Wolf requested instead a posting on the Kurita frontier.

This broke two precedents — Wolf's Dragoons had never before returned to an employer (House Davion employed this enigmatic unit when they first appeared from the Periphery). And the Dragoons had written into their previous contracts that they not be sent against their most recent former employer.

Wolf-watchers will remember that the Dragoons take care of their own. Remember what happened in 3015 when Anton Marik executed 28 Dragoons, one of them Col Wolf's brother Joshua? *That* revenge ended with Anton dead, his forces scattered, and his rebellion crushed. House Kurita had killed Dragoon non-combatants, falsified the unit's reputation, and cheated on their contract. For Col Wolf and his warriors, this was now a personal fight.

Col Wolf made it personal to Coordinator Takashi Kurita too. At the Davion-Steiner wedding, he returned Gen Tetsuhara's swords to the Coordinator, with a crushing — and public — comparison of the honor of Commander and vassal. Takashi Kurita's obsession with crushing the Dragoons was to cost him any chance of victory in the Fourth Succession War. The Coordinator had achieved a brilliant defensive alliance with Houses Liao and Marik. Instead of coordinating military forces with his two allies; in place of the hardheaded, economical use of his own forces which had come to be a hallmark of Takashi's generalship long before he became Coordinator; the head of House Kurita threw all of his attention and most of his best troops against the Dragoons in the Harrow's Sun system.

By the end of May, the Dragoons were reduced to the size of a single

The Ghost Lady and The Wolf

battalion. They fought their way out of the system to rendezvous on the world of Crossing, where they would make their final stand. In September, 3029, the 5th, 8th, 12, and 16th Galedon Regulars, reinforced Wolf-fighters from the Harrow's Sun system, together with an elite DEST team assigned by Takashi Kurita himself, arrived on Crossing determined to eliminate every last Dragoon. Despite aid from their old comrades in arms of the Tenth Deneb Lights, the Dragoons were slowly forced back from one position to another. They played a deadly game of catch-me-if-you-can across this volcanic world until — well, remember Zeta Battalion? They received word (despite the ComStar Interdict on House Davion) of the flight from Harrow's Sun and decided that they had healed enough. Chartering ships with their own money, they streaked across Davion space to aid their cohorts on Crossing. They received the reward which history owes to brave men and so seldom pays. They were in time to join their comrades at the caldera of the extinct volcano Tartarus, reinforcing those bloodied fighters in the nick of time to win the last battle for the planet.

The final battle of the Wolf-Kurita war was a 'Mech to 'Mech duel. Only the DEST team remained in the fight as Col Wolf rendezvoused with Captain Kerensky. He came upon her dueling a DEST warrior known only as "the Ghost Lady". Kerensky's Warhammer seemed to be losing to the Ghost's Archer. Ordering a furious Natasha Kerensky to break off the attack, Col Wolf engaged the Lady in an Archer to Archer duel. When her long-range fire crippled Col Wolf's 'Mech, the Lady Ghost moved into closer range for hand to hand combat. This combat ended with her death, despite Col Wolf's personal rescue of the warrior from her wrecked Archer seconds before it exploded. The identity of this warrior will never be known.

Simulator data

During the final battle on Crossing, an unknown female MechWarrior of the DEST company piloting an Archer upheld the highest traditions of the Dragoon. She had singlehandedly accounted for several of the famed Black Widows, and seemed to be conquering Natasha Kerensky herself when Col Jaime Wolf arrived. He ordered an irate Capt Kerensky out of battle and took her place. Archer to Archer, the duel continued, the Wolf and the Ghost Lady.

Game Setup:

Set two BattleTech boards end to end. The opponents start from either end and proceed till one is destroyed. Each board has five 2-hex hardcover positions; assign these at random or take turns in placing them.

Defender:

Col Jaime Wolf:
Piloting 1, Gunnery 1
Archer: ammo down 1/2
Damage: 1 point from head, 8 points from CT, 3 points from LA, 10 points from RL.

Attacker:

Ghost Lady: Piloting 1, Gunnery 2
Archer: ammo down 1/2
Damage: 4 points from RT, 4 points from LT, 3 points from LL, 10 points from RA.

One week later, the last of House Kurita's forces had left the planet. Wolf's Dragoons had fought the Combine to a standstill.

Decimated: Adjective form of the verb to decimate.

Descriptive of an old Roman punishment where a mutinous cohort was stood to in parade formation, and every tenth man was pulled out and summarily executed. By extension, a decimated unit is one in which at least ten percent of the personnel have been killed or rendered unfit for action.

Chambers Military Encyclopedia, 3025 edition, Veda-Simmons Press, Highspire.

Wolf's Dragoons have been described by the popular press as decimated. Their condition is much worse than that. Since they left their various assignments for Misery in 3027, and began their series of battles with Takashi Kurita there, in the Galedon District, and at last on Crossing, they have been reduced from five regiments to barely one. They have lost eighty percent of their personnel, most of them to death. Support and vehicle losses are proportionate.

The Dragoons have been granted the planet of Outreach, in the former Tikinov Commonality for their base under the terms of their agreement with the Federated Suns (now to be called the "Federated Commonwealth"). We at *BattleTechnology* can only wish them a long rest and a good recovery.

A noted journalist, Bob Carter became editor of *BattleTechnology* in 3028, just after the Fourth Succession War began. He serves as our editor-at-large, going wherever the action is. He admits to a fascination with Wolf's Dragoons. Bob Carter modestly claims that his Wolf's Dragoons scrapbook has reached thirty volumes.

Unit Update

BattleTechnology takes pride in publishing the names and conditions of the Dragoon survivors. You will notice that in some cases only one name remains of a lance, yet the Dragoons were still ready to do battle. We regret to say that names are not available yet for infantry, Aerospace, VTOL, tank, or other non-'Mech units. This is not due to any lack of respect for those brave warriors; it's simply that 'Mechs are much easier to spot from the air; Wolf's Dragoons have not yet appointed a new press officer, and no statistics are available from them. Mercenary units of this standard of pride are rare; units which combine this pride with the awesome fighting readiness of the Dragoons are rarer still.

Regimental Command Lance

Col Jaime Wolf, Archer
Capt John Umaio (*badly injured*), 'Mechless
Lt Hans Vordel, Thunderbolt
Lt James Riker (*badly injured*), 'Mechless
Sgt John Marlowe, Zeus
Hal Blumberg, Blackjack
Lauren Simmons (*badly injured*), salvaged Wolfhound

First Provisional Company

Command Lance

Lt Norah Stokes (*injured*), Griffin
Lt Corwin Grimaldi (*seriously injured*),
salvaged Grasshopper
Lt Wyatt "Kansas" Kennon, Hunchback

Fire Lance

Capt Loren Weller, Wolverine
Lt Perry Norton, Crusader
Bradley Turow, Wasp
Lilith Lang, Hermes II

Medium Lance

Lt Candace "Tigress" Halstrom, Quickdraw

Scout Lance

Jason Mac Auliffe, Stinger
Maurice Frenn (*Severely injured*), 'Mechless
Zdislaw Wawrzynczak, salvaged Wasp

Heavy Lance

Lt Danielle Montclair, salvaged Stalker
Sgt Jennie Gerald, Griffin
Darnell Winningham (*injured*), Enforcer
Shelton Woolrich, Crusader

Assault Lance

Sgt Lloyd Morton (*injured*), Archer
Paul Ziegler (*severely injured*), salvaged Archer

Command Lance

Capt Roger Singh (*crippled*), Marauder
Lt Drew "Easy" Lanier (*badly injured*),
damaged Locust
Lt Matt Kirby, Crusader
Sgt Irwin Tyrell, salvaged Enforcer

Recon Lance

Lt Lester Malawsky, Firefly
Sgt Gordon "Buck" Manney (*disabled*), 'Mechless
Simon Moore, salvaged Valkyrie

Medium Lance

Lt Susan Farhill, salvaged Wolfhound

Assault Lance

Wilson Smaller (*badly injured*), salvaged Imp
Omar Fazio (*crippled*), 'Mechless

Third Provisional Company

Command Lance

Maj Stanford Blake (*severely injured*), Battlemaster
Lt Frank Trent (*badly injured*), servicable Thunderbolt
Lt Gerald Buskirk (*injured*), Phoenix Hawk
Sgt Thomas West, Whitworth
Thom Domingues (*injured*), Commando
Kathy Kergun (*severely injured*), Orion

Medium Lance

Keith Gaitlin, Commando

Heavy Lance

Arthur Kaneko, salvaged Victor

Strike Lance

Lt Carter "Broke" Trent, Stinger

Recon Lance

Lt "Bullseye" Bill Target (*severely injured*),
serviceable Phoenix Hawk

Fire Lance

Lt Peter Geffen, Marauder
Vittorio Vistee, Shadow Hawk

Wolf's Dragoons: What Remains?

Fourth Provisional Company

Command Lance

Major Neil Parella, Marauder
Capt Ben Paxon, Hatchetman
Lt Oliver Hazell (*severely injured*),
damaged Assassin
Lt Leslie Kawalli (*injured*),
damaged Enforcer (Davion 'Mech)

Recon Lance

Lt Alan Delany, Vindicator

Assault Lance

Timothy Storrs, Charger

Fire Lance

Lt Arthur Figgis,
badly damaged Dervish
Sgt Sandina (*injured*), Firestarter
Hima Fural, Wolverine

Medium Lance

Lt Bart Steed (*partially paralysed*),
heavily damaged Cicada
Charles Bruen (*severely injured*),
badly damaged Dervish
Matthew Lanier (*severely injured*),
badly damaged Scorpion
Priotika Kareem, Dragon

Fifth Provisional Company

Command Lance

Major Patrick Chan, Valkyrie

Scout Lance

Donal McDonald, 'Mechless

Others

Col Wilhelmina Khorst, Marauder II
Col Kathleen Dumont, 'Mechless
Trel Morkai, Rifleman (Kurita)
Captain Dechan Fraser
(*on special assignment*),
Shadow Hawk

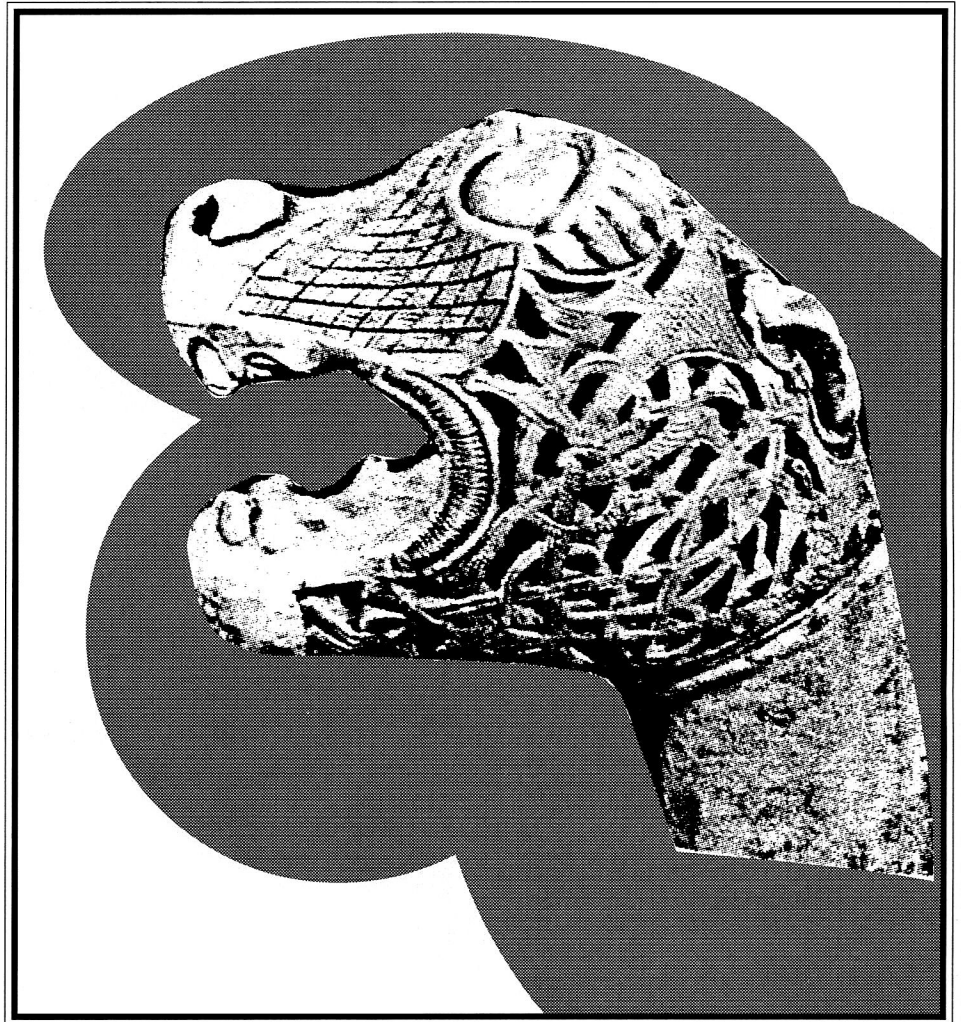

*Antique Irish Wolf
Set up as a Monument to Wolf's Dragoons' dead at Tartarus Caldera
Sent by anonymous donor, obviously a collector*



Tooth & Claw



The Hornet

Simulator Stats

Type: Hornet	Tons	
Tonnage: 20 Tons		20
Internal Structure:		2
Engine: Hermes 100		3
Walking MPs: 5		
Running MPs: 8		
Jumping MPs: 5		
Heat Sinks:	10	
Gyro:	1	
Cockpit:	3	
Armor Factor: 64	4	
Internal Structure	Armor Value	
Head:	3	8
Center Torso:	6	8 / 4
Rt/Lt Torso:	5	8 / 2
Rt/Lt Arm:	3	6
Rt/Lt Leg:	4	6

Weapons and Ammo

Item	Location	Critical	Tons
LRM 5:	RT	1	2
AMMO			
LRM-5: (24)	LT	1	1
Medium Laser:	RA	1	1
Small Laser:	LA	1	1
Medium Laser:	LT	1	.5
Jump Jets :	RL	2	1
Jump Jets:	LL	2	1
Jump Jet :	CT	1	.5

Background:

On October 9, 3029 the 5th Provisional Company of Wolf's Dragoons faced off against the 5th Galedon Regulars on the planet Crossing at the north face of an extinct volcano, Tartarus Caldera. The Dragoons were spread out over the caldera when the 5th Galedon (a regiment known for mountain fighting) came up the north face and penetrated their positions. This pushed Wolf's Dragoons into a forced modification to their perimeter, and gave the Kuritans an excellent foothold for the rest of the siege.

Defender Set Up:

Use 2 BattleTech maps end to end lengthwise. The maps should be considered all rough terrain and the defender may allocate 12 hexes as hard cover to be placed anywhere on the boards (but no more than two hexes together at any point). The defenders may then set up anywhere but within 4 hexes of the eastern side of the board.

Defender:

Elements of the Fifth Provisional Company, Wolf's Dragoons
 Maj Patrick Chan: Piloting 2, Gunnery 1 *Valkyrie*, 2 pt armor missing from LT
 Lt Thomas West: Piloting 2, Gunnery 3 *Whitworth*, +1 to hit because sensor hit taken; medium laser in head is inoperable
 Trel Markai: Piloting 1, Gunnery 2 *Rifleman-K* (see insert) no damage
 Donal Cameron: Piloting 1, Gunnery 2 *Javelin*, +2 to all piloting rolls due to gyro damage
 Donald McDonald: Piloting 3, Gunnery 3 *Hornet* (see insert), perfect condition

Attacker Set-up:

The attackers are Shito's Company of the 5th Galedon Regulars. Their set up is as follows; the first lance up is the medium lance, which enters at the start of the scenario. Roll one D6. If a 1-4 is rolled, on the third turn one of the next two lances shows up. (Roll one D6 again: on a 1-4 the Recon lance will come first; on a 5-6, it will be the command lance.) If a 5 or a 6 is rolled on the initial roll, the unit does not enter: each turn the roll must be made again until a roll of 1-4 is achieved. Then the rolls must be made again until the third lance shows up, again on a roll of 1-4.

Each pilot must make a piloting skill roll of +3 as he enters to remain standing. He may choose to crawl over the edge, but then he must make a piloting roll to stand up. A backwards fall takes him off of the cliff and out of the scenario. In this simulation we need not consider a falling climber as possibly knocking others off the cliff. All attackers are fitted with 'lobster claws'; see special rules about these devices.

Attacker: Shito's Company

Command Lance (enters second or third)
 Capt Hiro Shito: Piloting 2, Gunnery 3 *Victor*, perfect condition
 Jason Marion: Piloting 4, Gunnery 3 *Griffin*, CT jump jet inoperable (jump mp 4)

Tartarus Caldera, Crossing, October 9, 3029

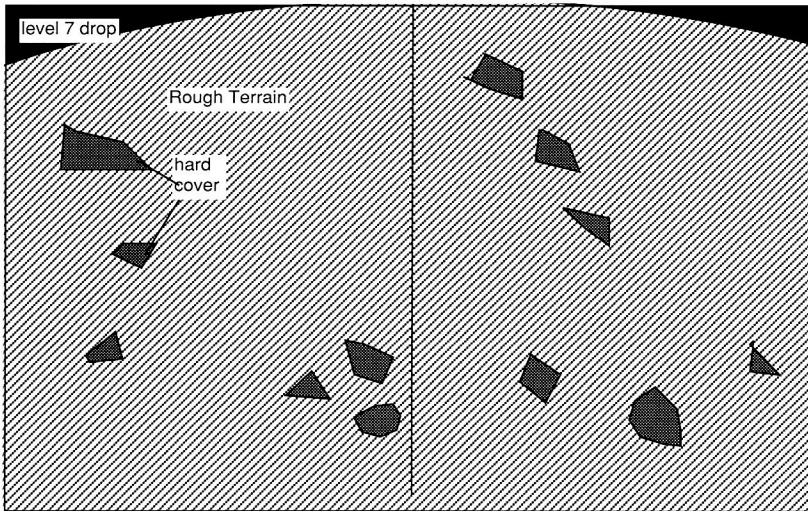

Rdzic Treval: Piloting 2, Gunnery 5 *Grasshopper*, perfect condition
 Zan Bengtsson: Piloting 2, Gunnery 4 *Wolverine*, engine damage (+3 to heat per turn)

Medium Lance (enters first)

Lt Jiro Hikaru: Piloting 1, Gunnery 1 *Panther*, perfect condition
 Sgt Sara Cairns: Piloting 4, Gunnery 2 *Wolverine*, 2 heat sinks gone
 Jasmine Rose: Piloting 3, Gunnery 4 *Jenner*, 3 pts of armor off RL, 4 pts off CT
 Saito Namusson: Piloting 2, Gunnery 4 *Jenner*, perfect condition

Recon Lance (enters second or third)

Lt Eden Christensen: Piloting 3, Gunnery 2 *Panther*, perfect condition
 Sergio "Reds" Redingsson: Piloting 2, Gunnery 4 *Stinger*, perfect condition
 Betina Cason: Piloting 3, Gunnery 5 *Panther* much damaged +1 to hit, +3 heat/turn, 4 pt off CT
 Clavell Jameson: Piloting 3, Gunnery 3 *Wasp* CT jump jet missing (jump mp of 5) 2 pts armor off LL

Victory Conditions:

Defender must hold position for 12 turns, then flee without losing more than 1/3 of their forces.

Attacker must wipe out defenders and hold captured area at any cost.

Lobster Claws:

These devices are specially created to assist 'Mechs in scaling cliffs that are too massive for their jump jets to get up. Basically, they are large spikes which are attached to the 'Mech's arms and feet; the 'Mech grinds them into the cliff face. The spikes themselves total up to 20% of the 'Mech's weight and are completely solid. When used to melee with (ie, to punch or to kick), they add +2 to damage; HOWEVER, because they are solid, they unbalance the 'Mech in any condition other than climbing. A piloting roll is necessary every time the 'Mech decides to move. If pilot is claw-trained (as the Fifth Galedons are), the roll is unmodified. If pilot has not received this training, the roll modifier is +3. The claws can be removed by triggering explosive charges, thus allowing the spikes to fall. This takes no appreciable time, nor does it add measurably to heat calculations. It is a long cumbersome process to reattach the spikes, involving a pilot or tech to assist while another 'Mech, a tech vehicle, or a ship's shop facility aids in maneuvering the tonnage. Under battlefield conditions, the claws are usually just abandoned. Because of the high percentage of knee-joint breakage, Death From Above is not recommended while wearing lobster claws.

Rifleman-K Variant (Kurita Design)

This variant modified the popular Rifleman by dropping the two Autocannon-5s. The variant is then fitted with:

Item	Location	Critical	Tons
large laser	RA	3	5
large laser	LA	3	5
SRM 4 pack	CT	1	2
Ammo (25)	CT	1	1

and 7 additional heat sinks.

This variant has the nickname of "Cool Head", as it partially makes up for the Rifleman's chronic overheating problem.

where
were
you?

BattleTechnology Question: Where were you when the Fourth Succession War began?

In August of 3028, Bennett's Cavaliers were on Robinson, en route to our base in the Periphery. Our ships were loaded with salvage from a four month extended raid into Kurita space, and most of the troops were looking forward to a little R&R.

Before leaving, I stopped by a local bar with two of my officers, Maj Charles Yamamoto and Capt Angelica Taylor. As I sipped away at a strawberry margarita, I examined the orders I had received at AFFS Headquarters. They consisted entirely of the message "Stay Tuned". We were rather used to vague orders, as we operate semi-independently of the AFFS. This message, however, disturbed me a bit. As I tried to figure it out, the overhead holo played the infamous toast of "I give you the Capellan Confederation!" Instantly realizing the significance of the statement, we all choked on our drinks and raced back to the AFFS building. Within a day we were on our way to the zenith jump point with orders to support the third wave of Operation Rat. The Cavaliers were a bit disappointed to lose a six month vacation, but we all figured that life was about to become very interesting.

We couldn't have been more right.

Sincerely Yours,
Col Jonathan Bennett
Commander
Bennett's Cavaliers

Where was I? I had been brought to the Davion-Steiner wedding, as part of the Archon's escort. I had just been introduced to Col Jaime Wolf, or rather, he had recognized my name and had congratulated me on our victory over the 25th Lancers, when we were called to attention for the cake, and the Prince made his little speech. I swallowed my Steiner PPC in one gulp. My only thought at the time was "The Capellans are up the greater tributary of life without a means of propulsion."

Col Gunther Harold Bellows
Commander, Samos' Swordsmen

I was on detached duty to NAIS to assist in weapons testing on the ALI-1A Alliance. We heard numerous cadets cheering, and soon word of the invasion got down to the test range. At long last these upstart Capellans would be put in their proper place.

Lt Col Sheila Marie Bellows
Elite 472nd Assault Battalion
Samos' Swordsmen

Note: BattleTechnology's understands that Lt Col Bellows is currently #2 on the ranking list of the MechForce (a Known-Sphere-wide battlepreparedness group of mechwarriors). She, with her husband Col Gunther Harold Bellows, founded Samos' Swordsmen. The unit went to a great deal of trouble to send us recordings from a classified location on the frontlines with a request that we include their statements to mark the anniversary of the unit's founding. Congratulations.

I'm what you call a *ronin*, a masterless samurai. My LAM "Captain Fantastic" and I had been punished with a nowhere duty on the planet Icar in the Trelshire system of the Lyran Commonwealth. The planet is so poor that if the government had any money they'd pay you to take it over! Well, there I was standing on a mountain

ledge overlooking the starport when the sky lighted up with the exhausts of a dozen DropShips hitting atmosphere. My LAM was in flight mode..it soon resembled a great metal bird of prey, legs outstretched to a takeoff position..I knew something was up. I depressed the thruster pedals on the floor and took to the air. Reconfiguring to fighter mode, I streaked to what would turn out to be my unit's ticket to extermination.

Ssgt Michael M Terry

Where was I? That's right, my Merc unit, the Devil's Brigade, was working for the snakes. I had just come back from a field test on Styx, where we were stationed.

Back in '27, we helped the snakes ambush a big Lyran convoy in the La Grave system. The convoy fled to the planet to fight. The snakes were still fighting at the Nadir point against stiff aerospace support, so they sent us down after them. I spotted a beautiful BNC-3S Banshee variant; whoever was piloting it was one incredible pilot, but aside from that the Lyrans were a pushover. Although we had salvage rights I was sure the snakes would take this baby if they found out, so we hid the ruined 'Mech on board the Oceanus.

A year later of red tape, scrounging, and constantly borrowing the colonel's Tech, pulling every favor that I ever had just to get the parts for Woody, I was just climbing out of the canopy hatch after the field trial when Mark came running up screaming War. All I could think of was: now the Brigade could carry out their blood feud with the Federats in earnest. With Woody in top condition, I could ram the Lyrans own 95 tons of walking death down their stinking allies' throats.

Maj Randall N Bills
Devils Brigade

Due to the high level of creative participation, and the high volume of good entries, this write-in forum is extended for at least another month.

ComStar Census will return next issue.

MoreThan Warriors

Gehenna Regained (The Colonists' Lament)

by Sandusky Sorrell

Wasps, Spiders swoop down; plague the land;
bring destruction wherever they go.
Buzzing *Cicadas, Grasshoppers, Locusts*
Gnaw desolate paths across open field.
Their hordes attack with flame and shell;
make this world a dying hell.
Where it will end, only Lords know.

Battle lines drawn; neighbors lend no hand;
Lucifer himself flies in low.
Gehenna Regained, no fruits left from harvest;
hope withdraws; our fates are sealed.
Our hordes defend with shell and flame;
all things charred look much the same.
We pray someday *both* sides will go.

Warrior-Poet in Profile

Name: Sandusky Sorrell

Rank: MechWarrior

Unit: Command Company, Galt's Grenadiers, under contract to House Davion

Assignment: Capellan March, the Federated Suns

BattleMech: SHD-2H Shadow Hawk, *The Gopher*

Favorite Poetic Form: Any metered verse

Major Awards Received: none

Featured Poem: "Gehenna Regained"

Dedication: "To the hapless victims of war, wherever they may be found"

Editor's Note: This most unusual work is written as a single-braid septet, a two-stanza, fourteen line poem employing an ABCDEEB ABCDFFB rhyme scheme. This rare poetic form was briefly popular for romantic themes during the late 27th and early 28th centuries in certain areas of the Free Worlds League. It is difficult to explain how Sorrell even learned of the braided septet, not to mention choosing it for his own work.

Reprinted with permissions from *BattleBards: 31st Century Warrior-Poets and their Poetry* (sixth edition), Ty-sen Jay Ay (editor), Excalibur Press, New Avalon, 3025.

BattleTechnology readers will note that biographical information is already out of date; MechWarrior Sorrell now serves in the Galedon Military District of the Draconis Combine, serving with Galt's Grenadiers under contract to House Kurita.

BATTLETROOPS

A GAME OF URBAN MAN-TO-MAN COMBAT IN THE BATTLETECH UNIVERSE.

'Mechs take the glory. Men take the real estate.



**NEW!
A BOXED
GAME FOR
BATTLETECH**

'Kick the Can' — slang for ambushing a 'Mech.

BattleTroops is the game of personal combat in the age of the 'Mech. A unique movement and action system can resolve large battles quickly and realistically. The game features all facets of combat in the BattleTech system, including man to man, man to 'Mech, man to vehicle, and the use of normal infantry, jump troops, gun emplacements, and heavy weapons.

Look for BattleTroops where you buy games!

BattleTech, BattleTroops, and 'Mech are trademarks of the FASA Corporation. © 1989 FASA Corporation All rights reserved. FASA Corporation, P.O. Box 6930, Chicago, IL 60680. FASA products are exclusively distributed by TM Games • Chart House • Station Road • East Preston • Littlehamton • West Sussex BN16 3AG • England, and by JEDKO Games • 134 Cochranes Road • Moorabbin, Victoria • Australia 3189